

50 A 1200 V 150 °C junction temperature SCR in TOP3 package

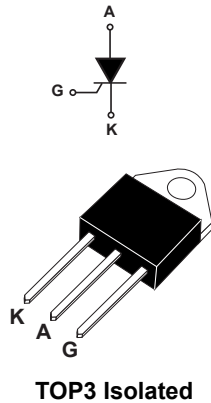

Features

- Max. blocking voltage = V_{DRM} , V_{RRM} = 1200 V
- Max. surge voltage = V_{DSM} , V_{RSM} = 1400 V
- I_{GT} maximum = 50 mA
- Max. junction temperature = 150 °C at V_D/V_R = 800 V
- High static and dynamic commutation:
 - di/dt = 200 A/ μ s
 - dV/dt = 1500 V/ μ s
- ECOPACK2 compliant component (RoHS and HF compliance)
- Complies with UL1557 standard (file ref: E81734) rated at 2.5 kV RMS thanks to its ceramic insulator
- UL94, level V0 molding resin compliance

Application

- Solar / Wind renewable energy inverters and rectifiers
- Solid state relay (SSR)
- Uninterruptible power supply (UPS)
- Bypass switch
- AC/DC inrush current limiter (ICL)
- AC/DC voltage controlled rectifier
- Battery charger
- Industrial welding systems
- Soft starter for motor drive
- Heating systems

Description

The TN5050H-12PI high temperature SCR is suitable in industrial applications where high immunity is required with a lower gate current, such as motor soft starter and power supply. In addition, its 1400 V surge capability brings robustness to grid application such as UPS or renewable energy inverters.

The insulated TOP3 package allows simplified design assembly thanks to its 2.5 kV certified rated insulation.

Product status

TN5050H-12PI

Product summary

$I_{T(RMS)}$	50 A
V_{DRM}/V_{RRM}	1200 V
V_{DSM}/V_{RSM}	1400 V
I_{GT} max.	50 mA
T_j max.	150 °C

1 Characteristics

Table 1. Absolute maximum ratings (limiting values)

Symbol	Parameter		Value	Unit
V_{DRM}, V_{RRM}	Repetitive peak off-state voltage (50-60 Hz)	$T_j = 125\text{ °C}$	1200	V
		$T_j = 150\text{ °C}$	800	
V_{DSM}, V_{RSM}	Non-repetitive surge voltage	$T_j = 25\text{ °C}$	1400	V
$I_{T(RMS)}$	On-state RMS current (180 ° conduction angle)	$T_c = 90\text{ °C}$	50	A
$I_{T(AV)}$	Average on-state current (180 ° conduction angle)		32	
I_{TSM}	Non repetitive surge peak on-state current (T_j initial = 25 °C), $V_R = 0\text{ V}$	$t_p = 8.3\text{ ms}$	493	A
		$t_p = 10\text{ ms}$	450	
I^2t	I^2t value for fusing	$t_p = 10\text{ ms}$	1013	A^2s
di/dt	Critical rate of rise of on-state current $I_G = 2 \times I_{GT}, t_r < 100\text{ ns}, T_j = 150\text{ °C}$	$f = 50\text{ Hz}$	200	$A/\mu s$
I_{GM}	Maximum peak positive gate current	$t_p = 20\text{ }\mu s$ $T_j = 150\text{ °C}$	8	A
V_{GM}	Maximum peak positive gate voltage		5	V
$P_{G(AV)}$	Average gate power dissipation	$T_j = 150\text{ °C}$	1	W
V_{RGM}	Maximum peak reverse gate voltage		3.5	V
T_{stg}	Storage junction temperature range		-40 to +150	°C
T_j	Operating junction temperature range		-40 to +150	

Table 2. Electrical characteristics ($T_j = 25\text{ °C}$ unless otherwise specified)

Symbol	Test conditions		Value	Unit
$I_{GT}^{(1)}$	$V_D = 12\text{ V}, R_L = 33\text{ }\Omega$	$T_j = -40\text{ °C}$	Max. 50	mA
	$V_D = 12\text{ V}, R_L = 33\text{ }\Omega$		90	
V_{GT}	$V_D = 12\text{ V}, R_L = 33\text{ }\Omega$		Max. 1.0	V
V_{GD}	$V_D = 800\text{ V}_{DRM}, R_L = 3.3\text{ k}\Omega$	$T_j = 150\text{ °C}$	Max. 0.15	V
$I_H^{(1)}$	$I_T = 500\text{ mA}$, gate open		Max. 100	mA
I_L	$I_G = 1.2 \times I_{GT}$		Max. 125	mA
$dV/dt^{(1)}$	$V_D = 67\% V_{DRM}$, gate open	$T_j = 125\text{ °C}$	Min. 2.0	$kV/\mu s$
		$T_j = 150\text{ °C}$	1.5	
t_{gt}	$I_T = 50\text{ A}, V_D = V_{DRM}, I_G = 100\text{ mA}$, $(dI_G/dt)_{max} = 0.2\text{ A}/\mu s$		Typ. 2.5	μs
t_q	$I_T = 50\text{ A}, V_D = 800\text{ V}$, $(dI/dt)_{max} = 10\text{ A}/\mu s$, $V_R = 25\text{ V}$, $dV/dt = 100\text{ V}/\mu s$	$T_j = 150\text{ °C}$	Typ. 150	μs

1. Measurements referenced to K.

Table 3. Static characteristics

Symbol	Test conditions			Value	Unit
V_{TM}	$I_{TM} = 64 \text{ A}$, $t_p = 380 \mu\text{s}$	$T_j = 25 \text{ }^\circ\text{C}$	Max.	1.55	V
V_{TO}	Threshold voltage	$T_j = 150 \text{ }^\circ\text{C}$	Max.	0.85	
R_D	Dynamic resistance	$T_j = 150 \text{ }^\circ\text{C}$	Max.	11	m Ω
I_{DRM} , I_{RRM}	$V_{DRM} = V_{RRM} = 1200 \text{ V}$	$T_j = 25 \text{ }^\circ\text{C}$	Max.	5	μA
		$T_j = 125 \text{ }^\circ\text{C}$		3.5	mA
	$V_{DRM} = V_{RRM} = 800 \text{ V}$	$T_j = 150 \text{ }^\circ\text{C}$		10	mA

Table 4. Thermal parameters

Symbol	Parameter		Value	Unit
$R_{th(j-c)}$	Junction to case (DC)	Typ.	0.9	$^\circ\text{C/W}$
$R_{th(j-a)}$	Junction to ambient	Typ.	50	

1.1 Characteristics curves

Figure 1. Maximum average power dissipation versus average on-state current

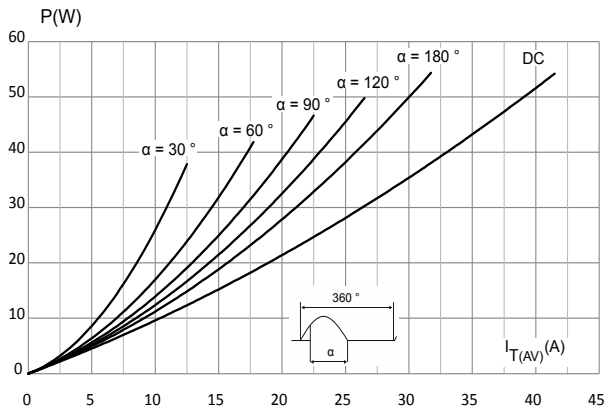

Figure 2. Average and DC on-state current versus case temperature

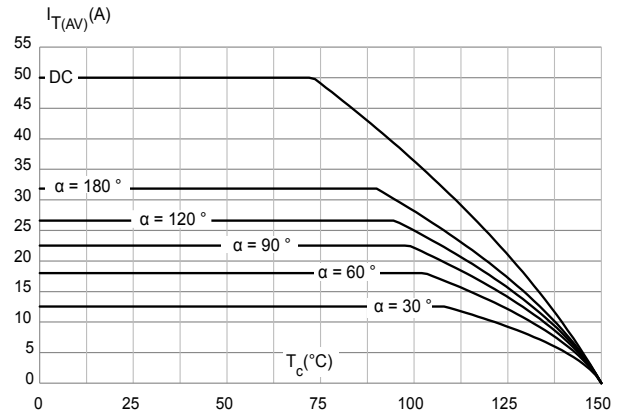

Figure 3. On-state characteristics (maximum values)

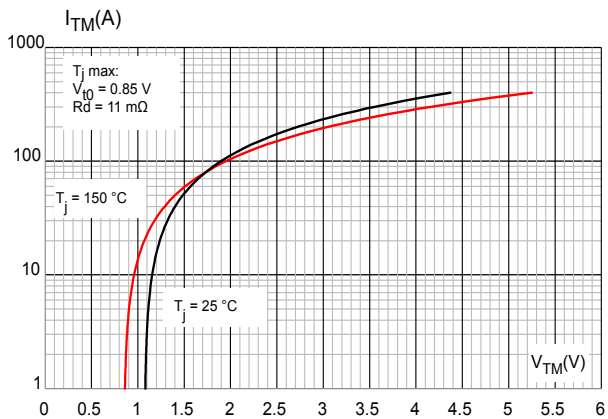

Figure 4. Average and D.C. on-state current versus ambient temperature

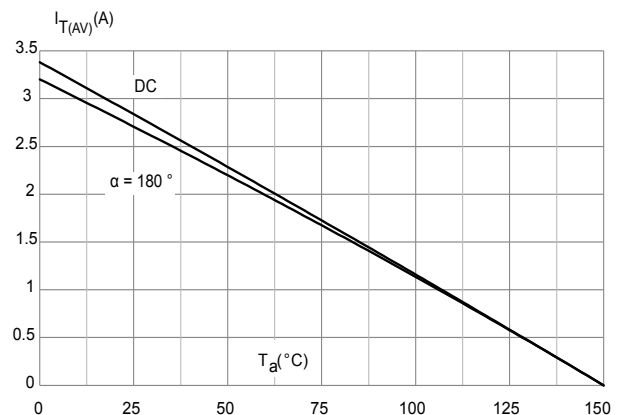

Figure 5. Relative variation of thermal impedance junction to case and junction to ambient versus pulse duration

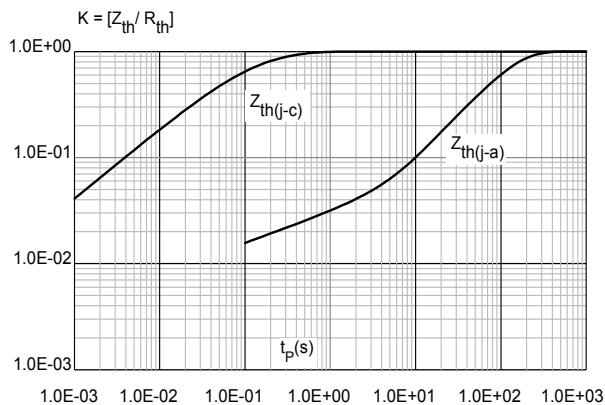

Figure 6. Surge peak on-state current versus number of cycles

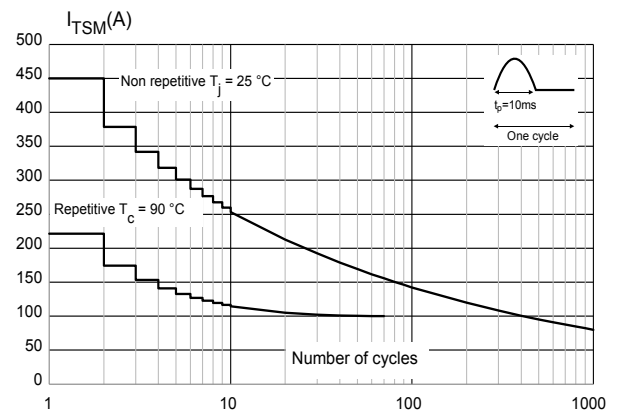

Figure 7. Non repetitive surge peak on-state current for a sinusoidal pulse with width $t_p < 10$ ms

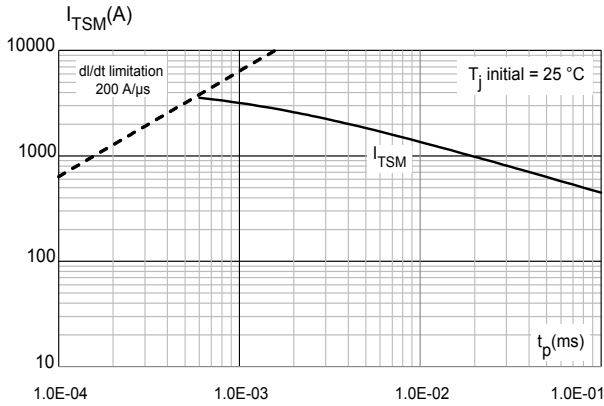

Figure 8. Relative variation of holding current and latching current versus junction temperature (typical values)

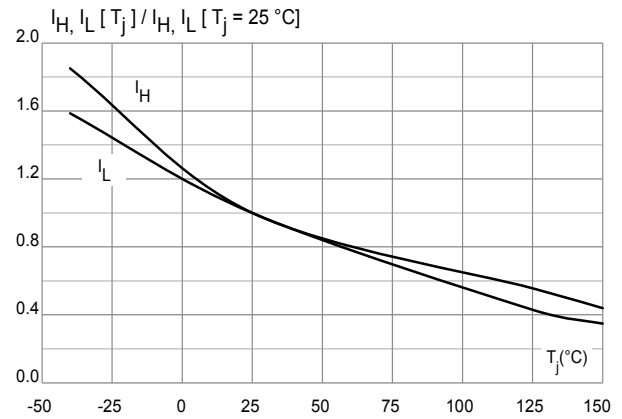

Figure 9. Relative variation of gate triggering current and voltage versus junction temperature

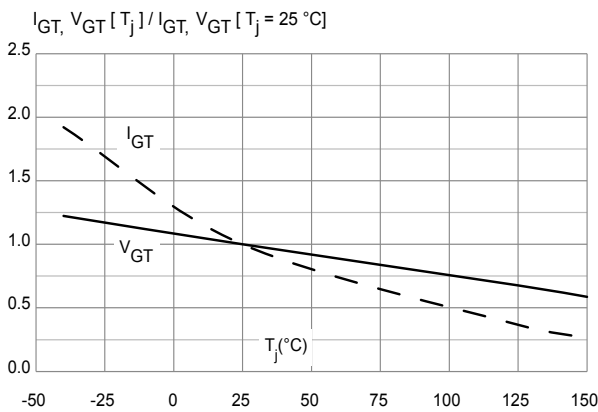

Figure 10. Relative variation of static dV/dt immunity versus junction temperature

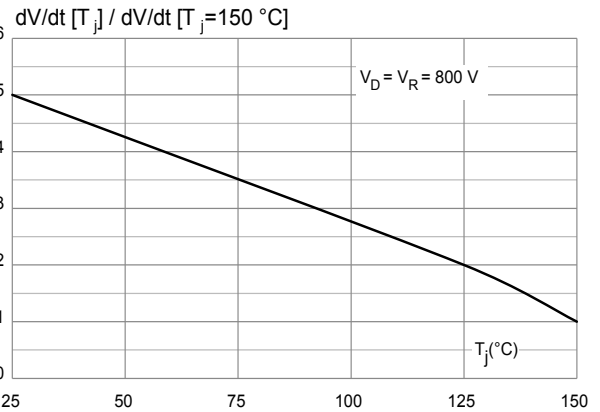
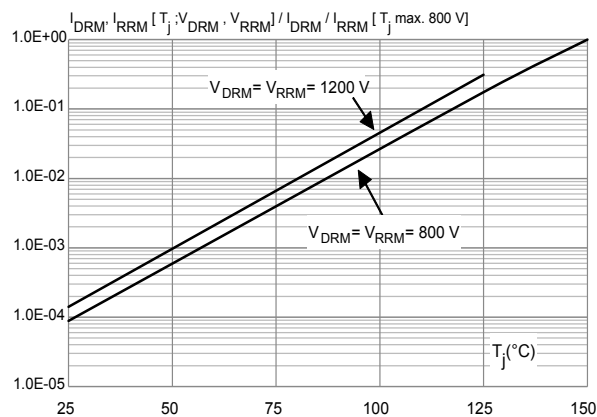

Figure 11. Relative variation of leakage current versus junction temperature for different values of blocking voltage (0.8 kV, 1.2 kV)



2 Application

2.1 Overvoltage surge management

The TN5050H-12PI specification in Table 1 gives a non-repetitive surge voltage forward V_{DSM} and reverse V_{RSM} at 1400 V, for a surge duration up to 10 ms duration at 25 °C of junction temperature. This feature allows designers headroom for overvoltage surge management in final application, reducing ratings of AC Line input protections, but also for an increased reliability of the overall application in the field, such as UPS, AC/DC converters or motor controllers.

Here below is an example of an overvoltage surge, as defined in IEC61000-4-5 electromagnetic compatibility standard, applied to the TN5050H-12PI. The Figure 12 details a simplified application front-end circuit, including the surge protection, made of metal oxide varistor, in parallel of the TN5050H-12PI.

Figure 12. Simplified front-end circuit using TN5050H-12PI

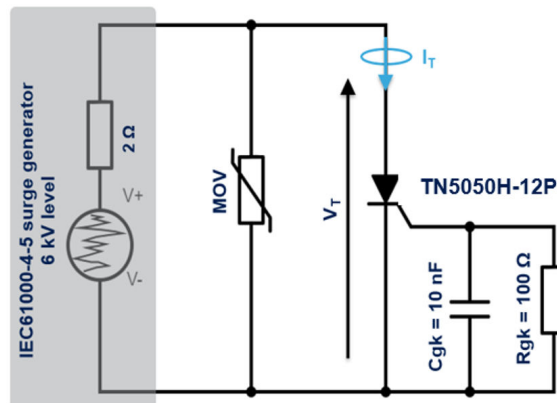

When an 1.2/50 μ s overvoltage surge occurs on the AC line, the application input protection clamps the voltage across the TN5050H-12PI SCR. Thanks to the extra V_{DSM} / V_{RSM} specification, the maximum allowed voltage across the SCR is 1400 V. The waveform Figure 13 right, illustrates the voltage across the AC line and the SCR during a 6 kV surge event, performed within the Figure 12 left test schematic, when the junction temperature equals the maximum junction temperature of the TN5050H-12PI: $T_j \text{ max} = 150 \text{ }^\circ\text{C}$, the device still withstands the stress when the occurrence is up to 10 surges, on each polarity, according to the IEC61000-4-5 standard.

Figure 13. Waveform of line and SCR voltages

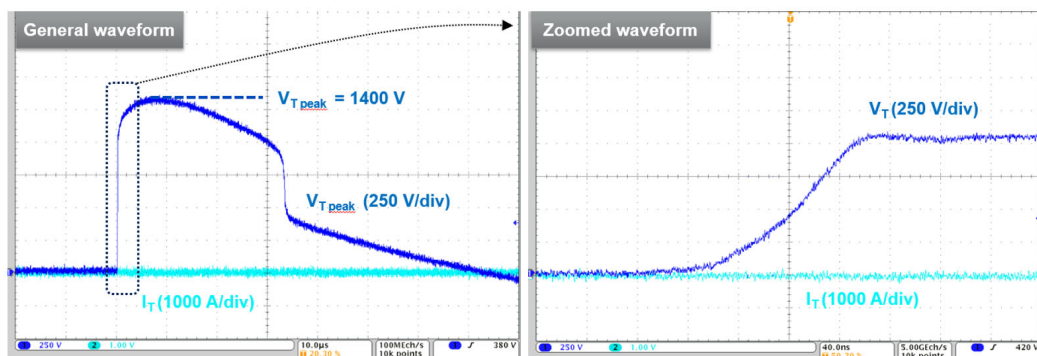

3 Package information

In order to meet environmental requirements, ST offers these devices in different grades of **ECOPACK** packages, depending on their level of environmental compliance. ECOPACK specifications, grade definitions and product status are available at: www.st.com. ECOPACK is an ST trademark.

3.1 TOP3 insulated package information

- **ECOPACK** (lead-free plating and halogen free package compliance)
- Lead-free package leads finishing
- Halogen-free molding compound resin meets UL94 standard level V0
- Recommended torque: 1.05 N·m (max. torque: 1.2 N·m)

Figure 14. Package outline

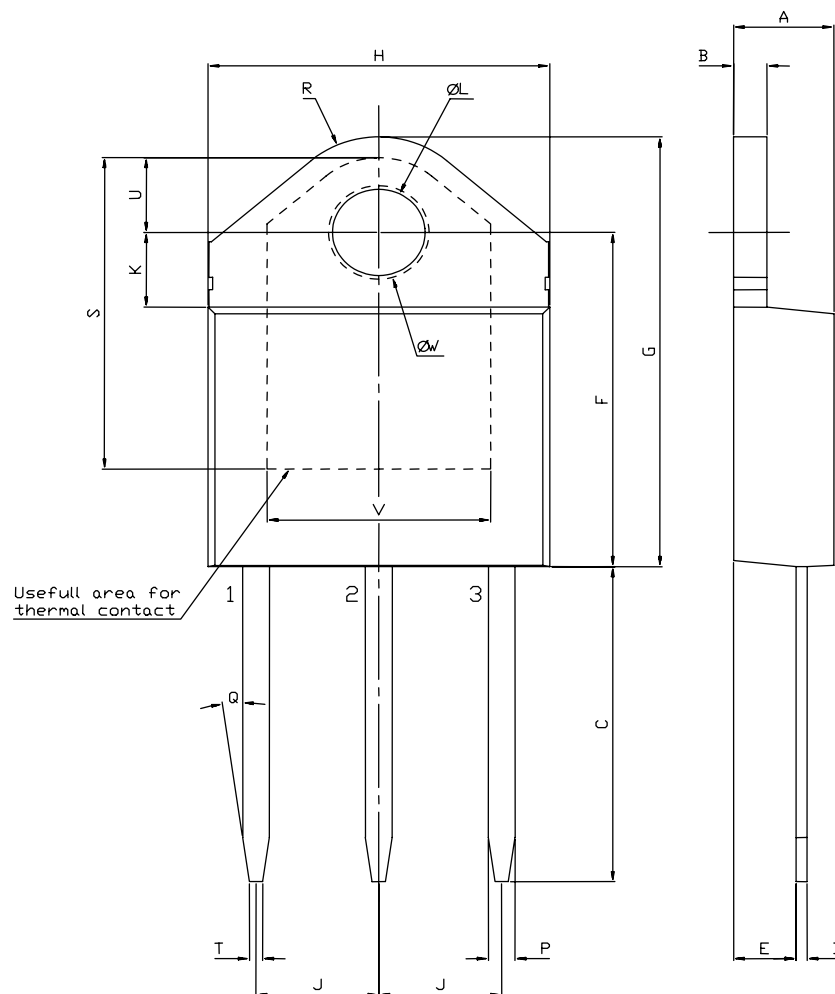

Table 5. Mechanical data

Ref.	Dimensions					
	mm			Inches ⁽¹⁾		
	Min.	Typ.	Max.	Min.	Typ.	Max.
A	4.40		4.60	0.1732		0.1811
B	1.45		1.55	0.0571		0.0610
C	14.35		15.60	0.5650		0.6142
D	0.50		0.70	0.0197		0.0276
E	2.70		2.90	0.1063		0.1142
F	15.80		16.50	0.6220		0.6496
G	20.40		21.10	0.8031		0.8307
H	15.10		15.50	0.5945		0.6102
J	5.40		5.65	0.2126		0.2224
K	3.40		3.65	0.1339		0.1437
L	4.08		4.17	0.1606		0.1642
P	1.10		1.30	0.0430		0.0510
R		4.60			0.1811	

1. Inches given for reference only

4 Ordering information

Figure 15. Ordering information scheme

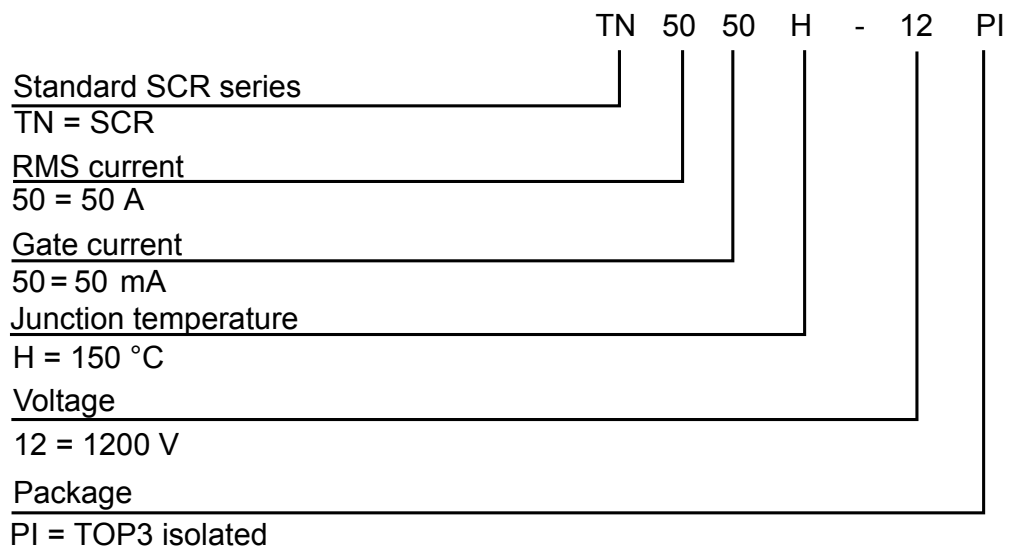

Table 6. Ordering information

Order code	Marking	Package	Weight	Base qty.	Delivery mode
TN5050H-12PI	TN5050H12	TOP3 insulated	4.48 g	30	Tube

Revision history

Table 7. Document revision history

Date	Revision	Changes
14-Apr-2023	1	Initial release.
27-Jul-2023	2	Updated Table 5. Mechanical data.

IMPORTANT NOTICE – READ CAREFULLY

STMicroelectronics NV and its subsidiaries (“ST”) reserve the right to make changes, corrections, enhancements, modifications, and improvements to ST products and/or to this document at any time without notice. Purchasers should obtain the latest relevant information on ST products before placing orders. ST products are sold pursuant to ST’s terms and conditions of sale in place at the time of order acknowledgment.

Purchasers are solely responsible for the choice, selection, and use of ST products and ST assumes no liability for application assistance or the design of purchasers’ products.

No license, express or implied, to any intellectual property right is granted by ST herein.

Resale of ST products with provisions different from the information set forth herein shall void any warranty granted by ST for such product.

ST and the ST logo are trademarks of ST. For additional information about ST trademarks, refer to www.st.com/trademarks. All other product or service names are the property of their respective owners.

Information in this document supersedes and replaces information previously supplied in any prior versions of this document.

© 2023 STMicroelectronics – All rights reserved