

## 60 A, 1200 V standard SCR

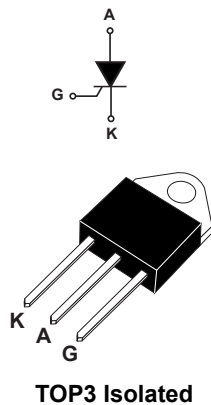

### Features

- Max. Repetitive Blocking Voltage =  $V_{DRM}$ ,  $V_{RRM}$  = 1200 V
- $I_{GT}$  maximum = 50 mA
- High static and dynamic commutation:
  - $di/dt$  = 100 A/ $\mu$ s
  - $dV/dt$  = 2000 V/ $\mu$ s
- **ECOPACK<sup>®2</sup>** component (RoHS and HF compliance)
- Complies with UL 1557 standard (File ref : E81734)

### Applications

- Solar / Wind renewable energy inverters and rectifiers
- Solid state relay (SSR)
- Uninterruptible power supply (UPS)
- Industrial SMPS
- Bypass
- AC DC inrush current limiter (ICL)
- Battery charger
- AC DC voltage controlled rectifier
- Industrial welding systems
- Off board automotive battery charger
- Soft starter
- Heating systems

### Description

The **TN6050-12PI** SCR is suitable in industrial applications where high immunity is required with a lower gate current and ceramic isolated tab, UL1557 certified rated at 2.5 kV RMS and UL94-V0 resin compliance.

Available in through-hole high power package TOP3 isolated tab.

Product status	
TN6050-12PI	
Product summary	
Order code	TN6050-12PI
Package	TOP3 isolated
$I_{T(RMS)}$	60 A
$V_{DRM}/V_{RRM}$	1200 V
$I_{GT}$	50 mA

# 1 Characteristics

**Table 1. Absolute maximum ratings (limiting values)**

Symbol	Parameter		Value	Unit	
$I_{T(RMS)}$	On-state RMS current (180 ° conduction angle)		60	A	
$I_{T(AV)}$	Average on-state current (180 ° conduction angle)				
$I_{TSM}$	Non repetitive surge peak on-state current ( $T_j$ initial = 25 °C)		$t_p = 8.3$ ms	763	A
			$t_p = 10$ ms	700	
$I^2t$	$I^2t$ value for fusing		$t_p = 10$ ms	2450	A <sup>2</sup> s
$di/dt$	Critical rate of rise of on-state current $I_G = 100$ mA, $di_G/dt = 1$ A/ $\mu$ s		$T_j = 25$ °C	100	A/ $\mu$ s
$I_{GM}$	Maximum peak positive gate current	$t_p = 20$ $\mu$ s	$T_j = 125$ °C	8	A
$V_{GM}$	Maximum peak positive gate voltage			5	V
$P_{G(AV)}$	Average gate power dissipation		$T_j = 125$ °C	1	W
$V_{RGM}$	Maximum peak reverse gate voltage			3.5	V
$T_{stg}$	Storage junction temperature range			-40 to +150	°C
$T_j$	Operating junction temperature range			-40 to +125	

**Table 2. Electrical characteristics ( $T_j = 25$  °C unless otherwise specified)**

Symbol	Test conditions		Value	Unit	
$I_{GT}$	$V_D = 12$ V, $R_L = 33$ $\Omega$		Min.	8	mA
			Max.	50	
$V_{GT}$			Max.	1.3	V
$V_{GD}$	$V_D = V_{DRM}$ , $R_L = 3.3$ k $\Omega$	$T_j = 125$ °C	Min.	0.2	V
$I_H$	$I_T = 500$ mA, gate open		Max.	100	mA
$I_L$	$I_G = 1.2 \times I_{GT}$		Max.	130	mA
$dV/dt$	$V_D = 67\%$ $V_{DRM}$ , gate open	$T_j = 125$ °C	Min.	2000	V/ $\mu$ s
$t_{gt}$	$I_T = 50$ A, $V_D = V_{DRM}$ , $I_G = 200$ mA, $(di_G/dt)_{max} = 0.2$ A/ $\mu$ s		Typ.	2	$\mu$ s
$t_q$	$I_{TM} = 50$ A, $V_D = 800$ V, $dI_{TM}/dt = 30$ A/ $\mu$ s, $V_R = 75$ V, $dV_D/dt = 20$ V/ $\mu$ s	$T_j = 125$ °C	Typ.	100	$\mu$ s

**Table 3. Static characteristics**

Symbol	Test conditions		Value	Unit		
$V_{TM}$	$I_{TM} = 120$ A, $t_p = 380$ $\mu$ s	$T_j = 25$ °C	Max.	1.75	V	
$V_{TO}$	Threshold voltage		$T_j = 125$ °C	Max.		0.93
$R_D$	Dynamic resistance		$T_j = 125$ °C	Max.	7.1	m $\Omega$
$I_{DRM}$ , $I_{RRM}$	$V_{DRM} = V_{RRM} = 1200$ V		$T_j = 25$ °C	Max.	10	$\mu$ A
			$T_j = 125$ °C		6.5	mA

**Table 4. Thermal parameters**

Symbol	Parameter		Value	Unit
$R_{th(j-c)}$	Junction to case (DC)	Typ.	0.70	°C/W
$R_{th(j-a)}$	Junction to ambient (DC)		50	

### 1.1 Characteristics curves

**Figure 1. Maximum average power dissipation versus average on-state current**

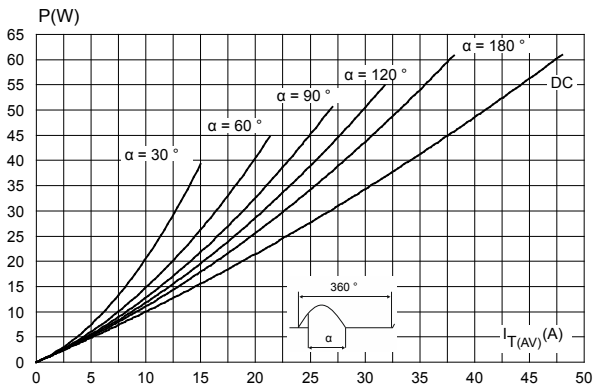

**Figure 2. Average and DC on-state current versus case temperature**

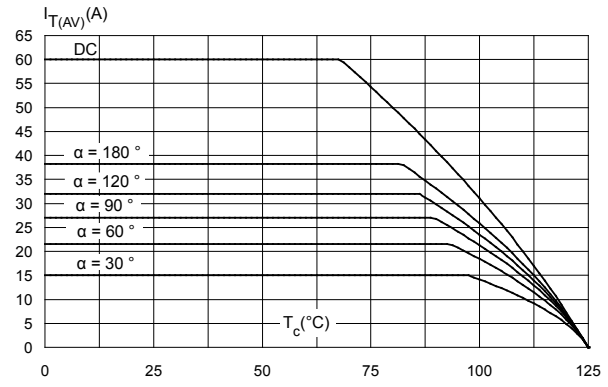

**Figure 3. On-state characteristics (maximum values)**

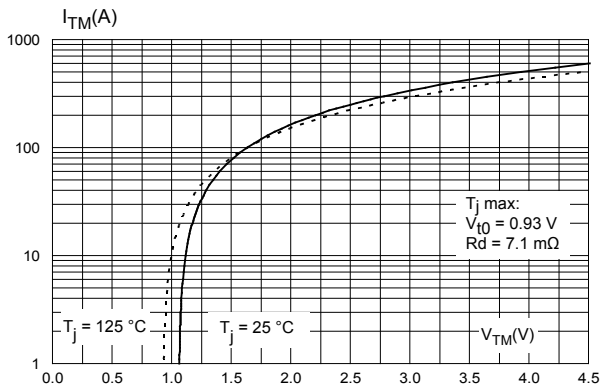

**Figure 4. Average and D.C. on-state current versus ambient temperature**

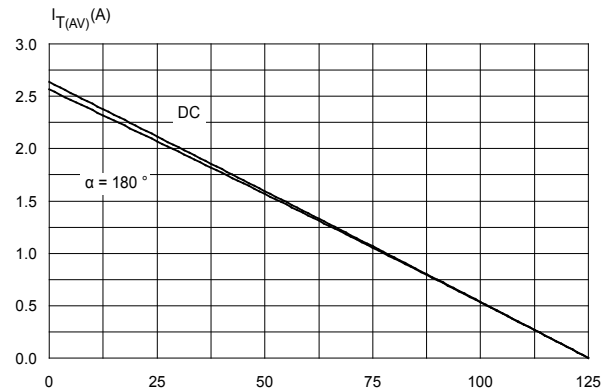

**Figure 5. Relative variation of thermal impedance junction to case and junction to ambient versus pulse duration**

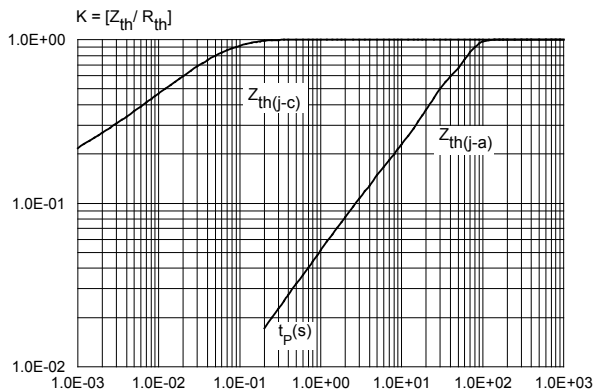

**Figure 6. Surge peak on-state current versus number of cycles**

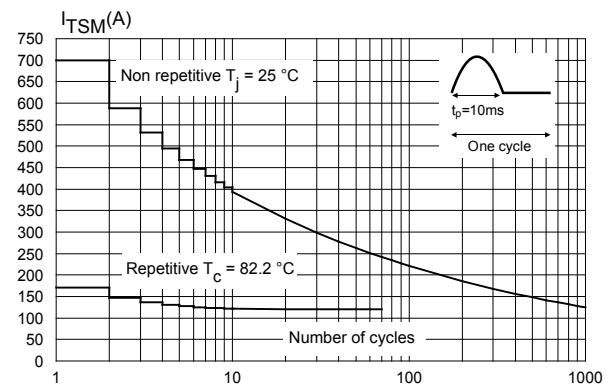

**Figure 7. Non repetitive surge peak on-state current for a sinusoidal pulse with width  $t_p < 10$  ms**

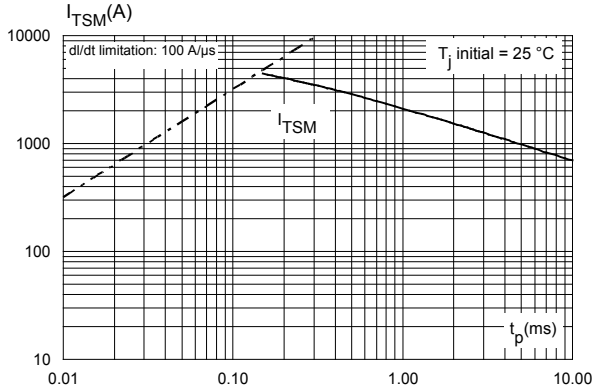

**Figure 8. Relative variation of gate trigger current and gate trigger voltage versus junction temperature (typical value)**

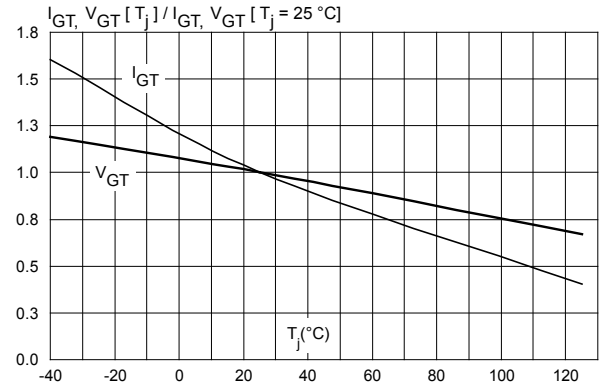

**Figure 9. Relative variation of holding and latching current versus junction temperature (typical value)**

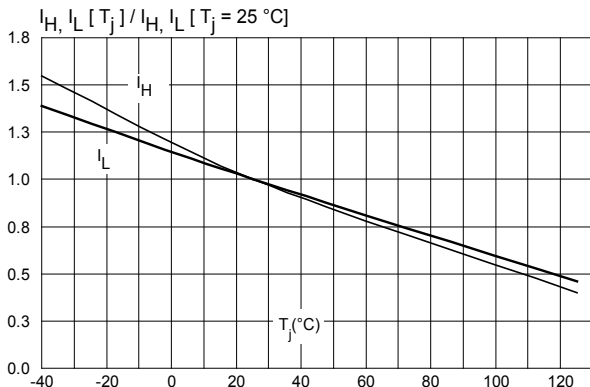

**Figure 10. Relative variation of static dV/dt immunity versus junction temperature**

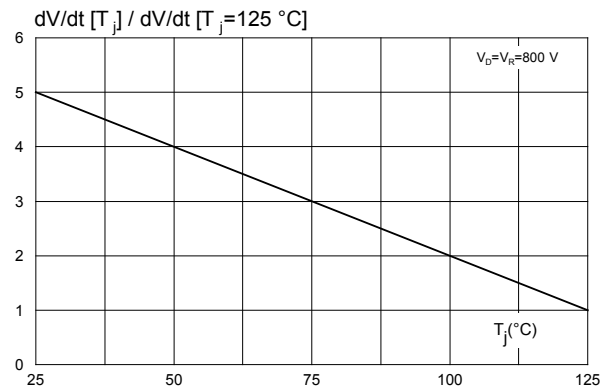

**Figure 11. Relative variation of leakage current versus junction temperature for different values of blocking voltage (typical values)**

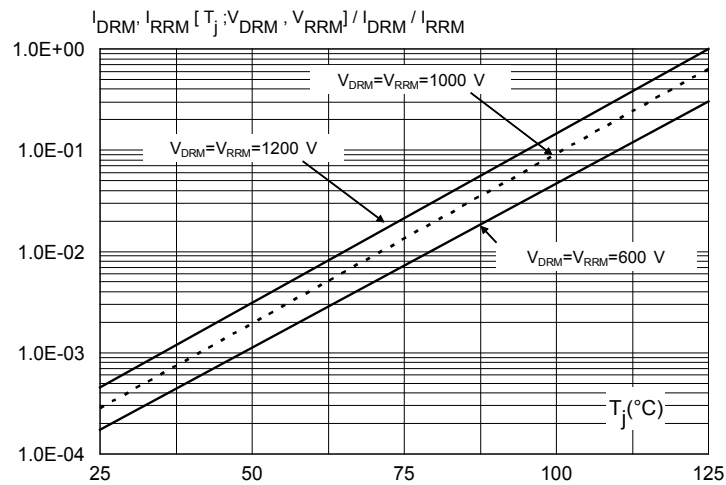

---

## 2 Package information

---

In order to meet environmental requirements, ST offers these devices in different grades of **ECOPACK®** packages, depending on their level of environmental compliance. ECOPACK® specifications, grade definitions and product status are available at: [www.st.com](http://www.st.com). ECOPACK® is an ST trademark.

### 2.1 TOP3 Isolated package information

- **ECOPACK®** (Lead-free plating and Halogen free package compliance)
- Lead-free package leads finishing
- Halogen-free molding compound resin meets UL94 standard level V0
- Recommended torque: 1.05 N·m (max. torque: 1.2 N·m)

Figure 12. TOP3 Isolated package outline

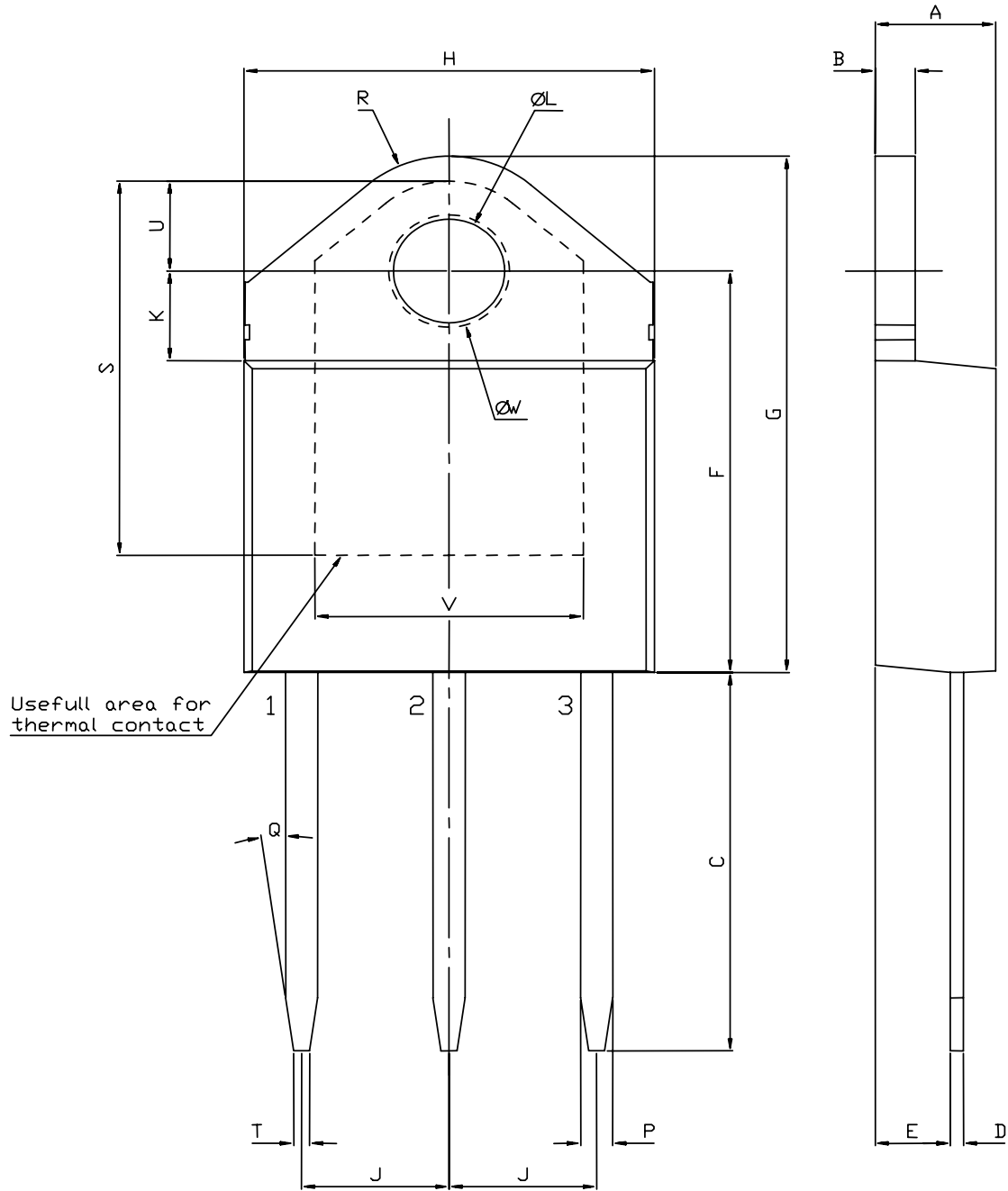

**Table 5. TOP3 Isolated mechanical data**

Ref.	Dimensions					
	mm			Inches <sup>(1)</sup>		
	Min.	Typ.	Max.	Min.	Typ.	Max.
A	4.40		4.60	0.1732		0.1811
B	1.45		1.55	0.0571		0.0610
C	14.35		15.60	0.5650		0.6142
D	0.50		0.70	0.0197		0.0276
E	2.70		2.90	0.1063		0.1142
F	15.80		16.50	0.6220		0.6496
G	20.40		21.10	0.8031		0.8307
H	15.10		15.50	0.5945		0.6102
J	5.40		5.65	0.2126		0.2224
K	3.40		3.65	0.1339		0.1437
L	4.08		4.17	0.1606		0.1642
M	1.20		1.40	0.0472		0.0551
R		4.60			0.1811	

1. Inches given for reference only



### 3 Ordering information

Figure 13. Ordering information scheme

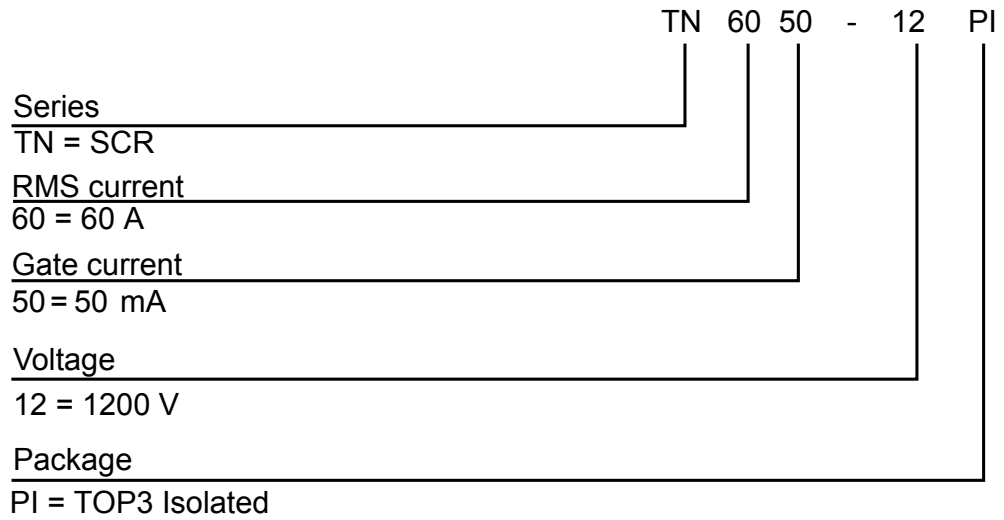

Table 6. Ordering information

Order code	Marking	Package	Weight	Base qty.	Delivery mode
TN6050-12PI	TN605012PI	TOP3 Isolated	4.48 g	30	Tube

## Revision history

**Table 7. Document revision history**

Date	Revision	Changes
14-Dec-2018	1	Initial release.

**IMPORTANT NOTICE – PLEASE READ CAREFULLY**

STMicroelectronics NV and its subsidiaries (“ST”) reserve the right to make changes, corrections, enhancements, modifications, and improvements to ST products and/or to this document at any time without notice. Purchasers should obtain the latest relevant information on ST products before placing orders. ST products are sold pursuant to ST’s terms and conditions of sale in place at the time of order acknowledgement.

Purchasers are solely responsible for the choice, selection, and use of ST products and ST assumes no liability for application assistance or the design of Purchasers’ products.

No license, express or implied, to any intellectual property right is granted by ST herein.

Resale of ST products with provisions different from the information set forth herein shall void any warranty granted by ST for such product.

ST and the ST logo are trademarks of ST. All other product or service names are the property of their respective owners.

Information in this document supersedes and replaces information previously supplied in any prior versions of this document.

© 2018 STMicroelectronics – All rights reserved