

### Features

- $I_{T(RMS)} = 0.8\text{ A}$
- $V_{DRM}, V_{RRM} = 600\text{ V}$
- $I_{GT} = 30\text{ to }200\ \mu\text{A}$

### Applications

- Limited gate current topologies
- Ground fault circuit interrupters
- Overvoltage crowbar protection in power supplies
- Protection in electronic ballasts
- Capacitive discharge ignitions
- Igniters (lighting, oven...)

### Description

The X006 SCR can be used as on/off function in applications where topology does not offer high current for gate triggering.

This device is optimized in forward voltage drop and inrush current capabilities for reduced power losses and high reliability in harsh environments.

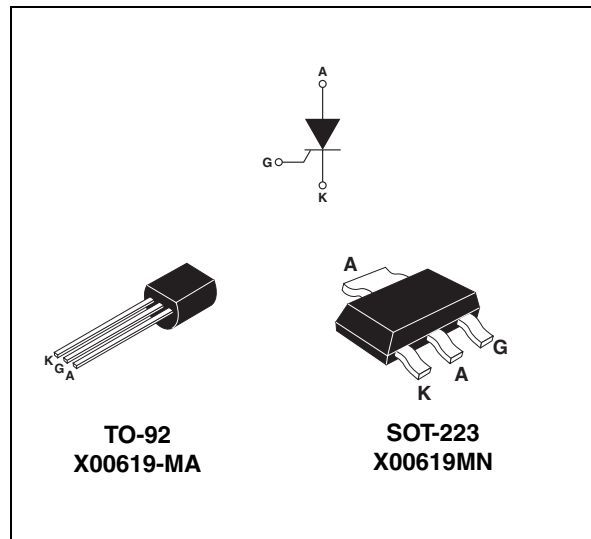

**Table 1. Device summary**

$I_{T(RMS)}$	0.8 A
$V_{DRM} / V_{RRM}$	600 V
$I_{GT}$	30 to 200 $\mu\text{A}$

# 1 Characteristics

**Table 2. Absolute ratings (limiting values,  $T_j = 25\text{ °C}$  unless otherwise specified)**

Symbol	Parameter		Value	Unit	
$I_{T(RMS)}$	On-state rms current (180 °Conduction angle)	TO-92	$T_L = 83\text{ °C}$	0.8	A
		SOT-223	$T_c = 107\text{ °C}$		
$I_{T(AV)}$	Average on-state current (180 °Conduction angle)	TO-92	$T_L = 83\text{ °C}$	0.5	A
		SOT-223	$T_c = 107\text{ °C}$		
$I_{TSM}$	Non repetitive surge peak on-state current	$t_p = 8.3\text{ ms}$	$T_j = 25\text{ °C}$	10	A
		$t_p = 10\text{ ms}$		9	
$I^2t$	$I^2t$ Value for fusing	$t_p = 10\text{ ms}$	$T_j = 25\text{ °C}$	0.4	$A^2s$
di/dt	Critical rate of rise of on-state current $I_G = 2 \times I_{GT}, t_r \leq 100\text{ ns}$	F = 60 Hz	$T_j = 125\text{ °C}$	50	$A/\mu s$
$I_{GM}$	Peak gate current	$t_p = 20\text{ }\mu s$	$T_j = 125\text{ °C}$	1	A
$P_{G(AV)}$	Average gate power dissipation		$T_j = 125\text{ °C}$	0.1	W
$T_{stg}$ $T_j$	Storage junction temperature range Operating junction temperature range			- 40 to + 150 - 40 to + 125	$^{\circ}C$

**Table 3. Electrical characteristics ( $T_j = 25\text{ °C}$  unless otherwise specified)**

Symbol	Test conditions		Value	Unit	
$I_{GT}$	$V_D = 12\text{ V}, R_L = 140\text{ }\Omega$	MIN.	30	$\mu A$	
		MAX.	200		
$V_{GT}$			0.8	V	
$V_{GD}$	$V_D = V_{DRM}, R_L = 3.3\text{ k}\Omega, R_{GK} = 1\text{ k}\Omega$	$T_j = 125\text{ °C}$	MIN.	0.2	V
$V_{RG}$	$I_{RG} = 10\text{ }\mu A$		MIN.	5	V
$I_H$	$I_T = 50\text{ mA}, R_{GK} = 1\text{ k}\Omega$		MAX.	5	mA
$I_L$	$I_G = 1\text{ mA}, R_{GK} = 1\text{ k}\Omega$		MAX.	6	mA
dV/dt	$V_D = 67\% V_{DRM}, R_{GK} = 1\text{ k}\Omega$	$T_j = 125\text{ °C}$	MIN.	40	$V/\mu s$

**Table 4. Static electrical characteristics**

Symbol	Test conditions		Value	Unit	
$V_{TM}$	$I_{TM} = 1\text{ A}, t_p = 380\text{ }\mu s$	$T_j = 25\text{ °C}$	MAX	1.35	V
$V_{TO}$	Threshold voltage	$T_j = 125\text{ °C}$		0.85	V
$R_d$	Dynamic resistance			245	$m\Omega$
$I_{DRM} I_{RRM}$	$V_{DRM} = V_{RRM}, R_{GK} = 1\text{ k}\Omega$	$T_j = 25\text{ °C}$		1	$\mu A$
		$T_j = 125\text{ °C}$	100	$\mu A$	

**Table 5. Thermal resistances**

Symbol	Parameter		Value	Unit
$R_{th(j-l)}$	Junction to leads (DC)	TO-92	Max.	°C/W
$R_{th(j-c)}$	Junction to case (DC)	SOT-223		
$R_{th(j-a)}$	Junction to ambient (DC)	TO-92		
		$S = 5 \text{ cm}^2$ SOT-223		

**Figure 1. Maximum average power dissipation versus average on-state current**

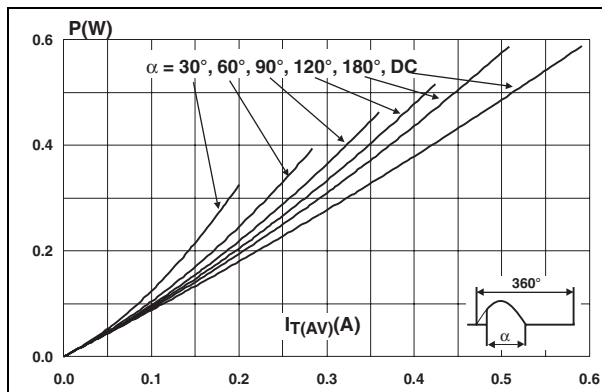

**Figure 2. Average and DC on-state current versus case temperature (SOT-223)**

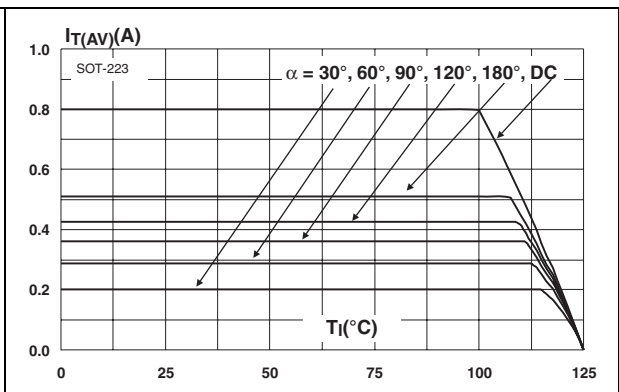

**Figure 3. Average and DC on-state current versus lead temperature (TO-92)**

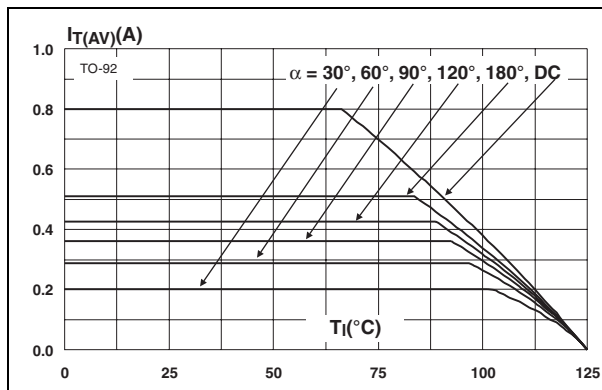

**Figure 4. Average and DC on-state current versus ambient temperature (free air convection)**

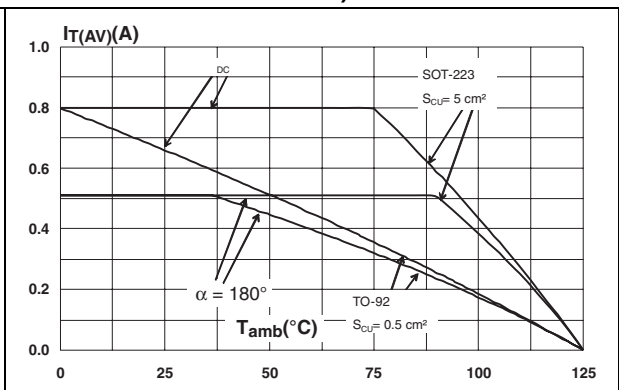

**Figure 5. Relative variation of thermal impedance junction to ambient versus pulse duration**

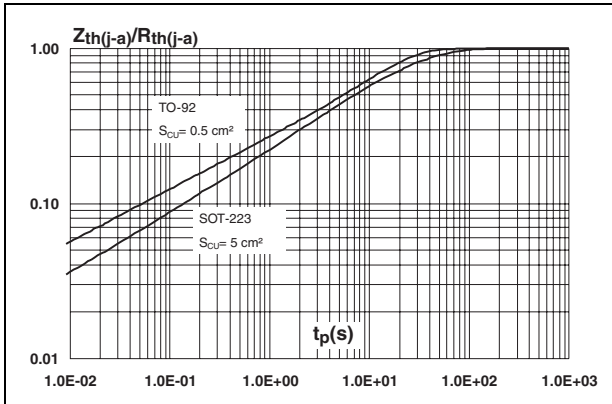

**Figure 6. Relative variation of gate trigger, holding and latching current versus junction temperature**

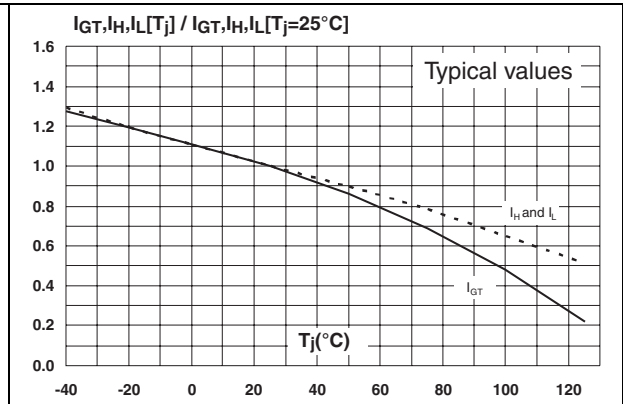

**Figure 7. Relative variation of holding current versus gate-cathode resistance (typical values)**

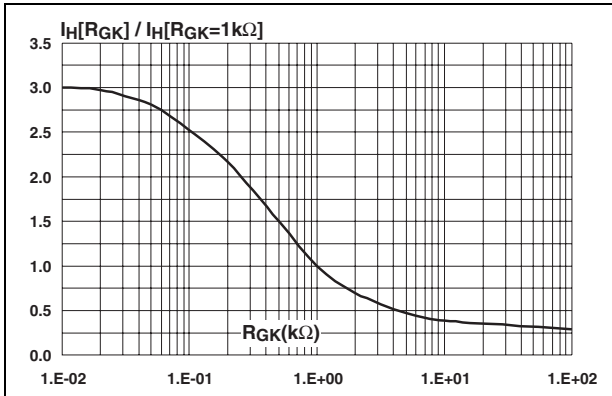

**Figure 8. Relative variation of dV/dt immunity versus gate-cathode resistance (typical values)**

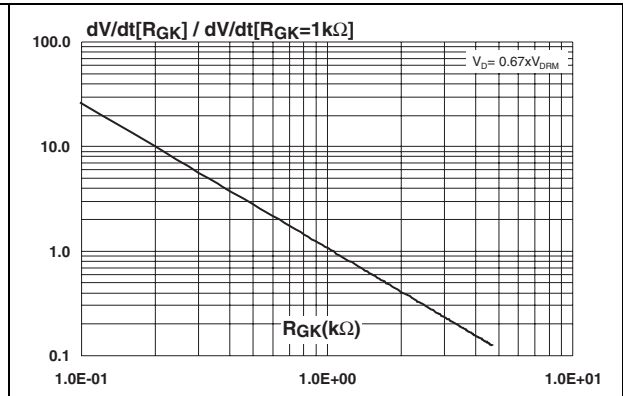

**Figure 9. Relative variation of dV/dt immunity versus gate-cathode capacitance (typical values)**

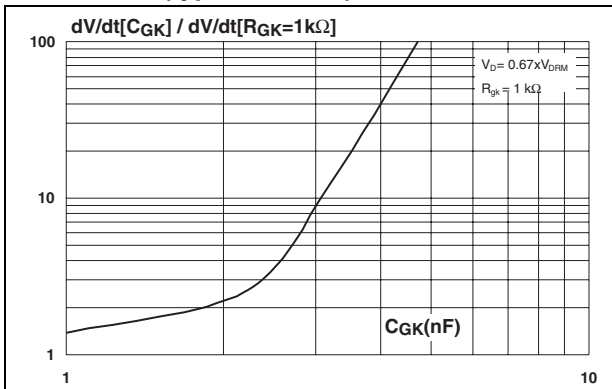

**Figure 10. Surge peak on-state current versus number of cycles**

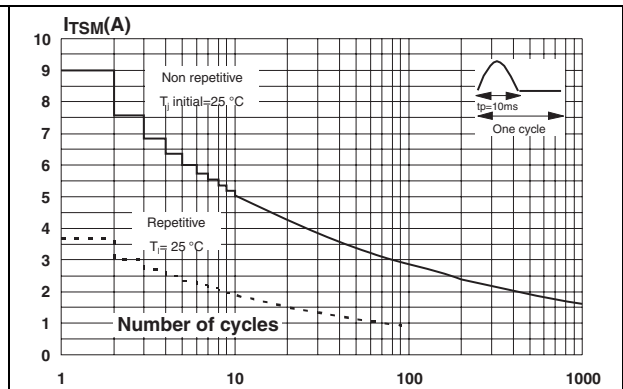

Figure 11. Non repetitive surge peak on state current for a sinusoidal pulse and corresponding value of  $I^2t$

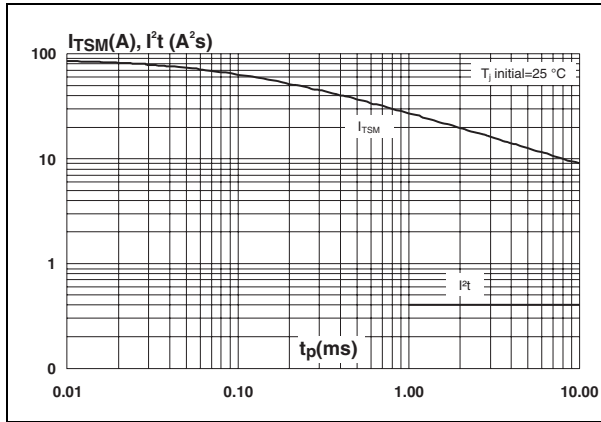

Figure 12. On-state characteristics (maximum values)

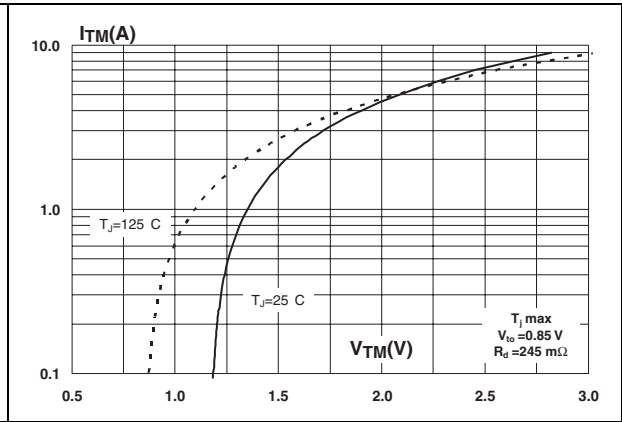
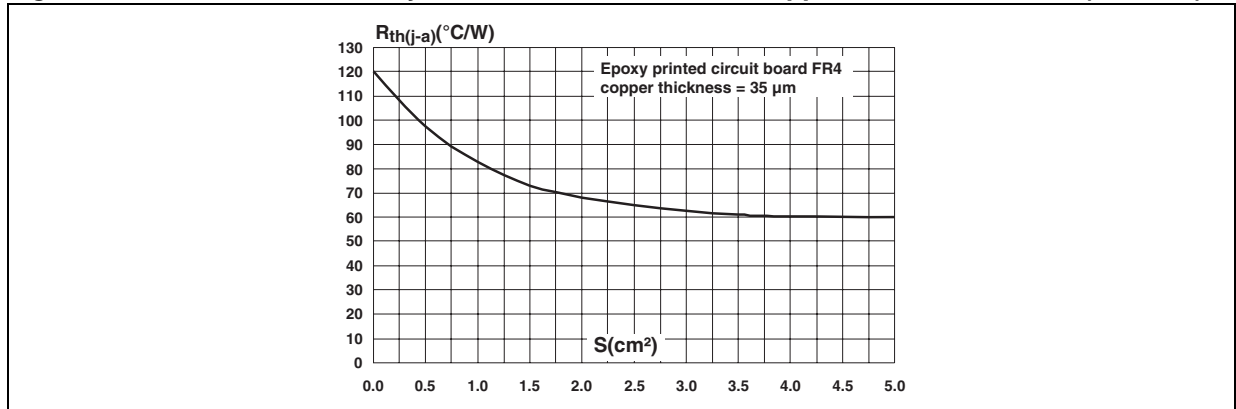
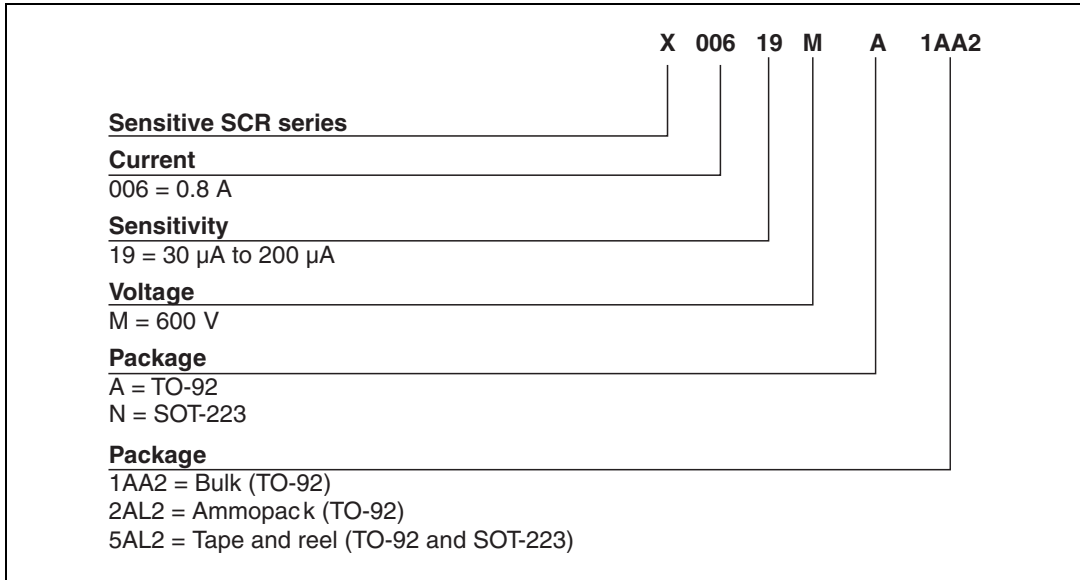

Figure 13. Thermal resistance junction to ambient versus copper surface under tab (SOT-223)



## 2 Ordering information scheme

Figure 14. Ordering information scheme







### 3 Package information

- Epoxy meets UL94, V0
- Lead-free packages

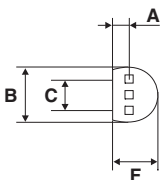
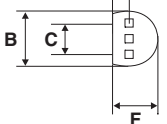
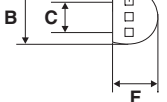
In order to meet environmental requirements, ST offers these devices in different grades of ECOPACK<sup>®</sup> packages, depending on their level of environmental compliance. ECOPACK<sup>®</sup> specifications, grade definitions and product status are available at: [www.st.com](http://www.st.com). ECOPACK<sup>®</sup> is an ST trademark.

**Table 6. TO-92 (plastic) dimensions**

	Dimensions						
	Ref.	Millimeters			Inches		
		Min.	Typ.	Max.	Min.	Typ.	Max.
	A	-	1.35	-	-	0.053	-
	B	-	-	4.70	-	-	0.185
	C	-	2.54	-	-	0.100	-
	D	4.40	-	-	0.173	-	-
	E	12.70	-	-	0.500	-	-
	F	-	-	3.70	-	-	0.146
	a	-	-	0.50	-	-	0.019

**Table 7. SOT-223 dimensions**

Ref.	Dimensions					
	Millimeters			Inches		
	Min.	Typ.	Max.	Min.	Typ.	Max.
A			1.80			0.071
A1		0.02	0.10		0.001	0.004
B	0.60	0.70	0.85	0.024	0.027	0.033
B1	2.90	3.00	3.15	0.114	0.118	0.124
c	0.24	0.26	0.35	0.009	0.010	0.014
D <sup>(1)</sup>	6.30	6.50	6.70	0.248	0.256	0.264
e		2.3			0.090	
e1		4.6			0.181	
E <sup>(1)</sup>	3.30	3.50	3.70	0.130	0.138	0.146
H	6.70	7.00	7.30	0.264	0.276	0.287
V	10° max					

1. Do not include mold flash or protrusions. Mold flash or protrusions shall not exceed 0.15mm (0.006inches)

**Figure 15. SOT-223 footprint**

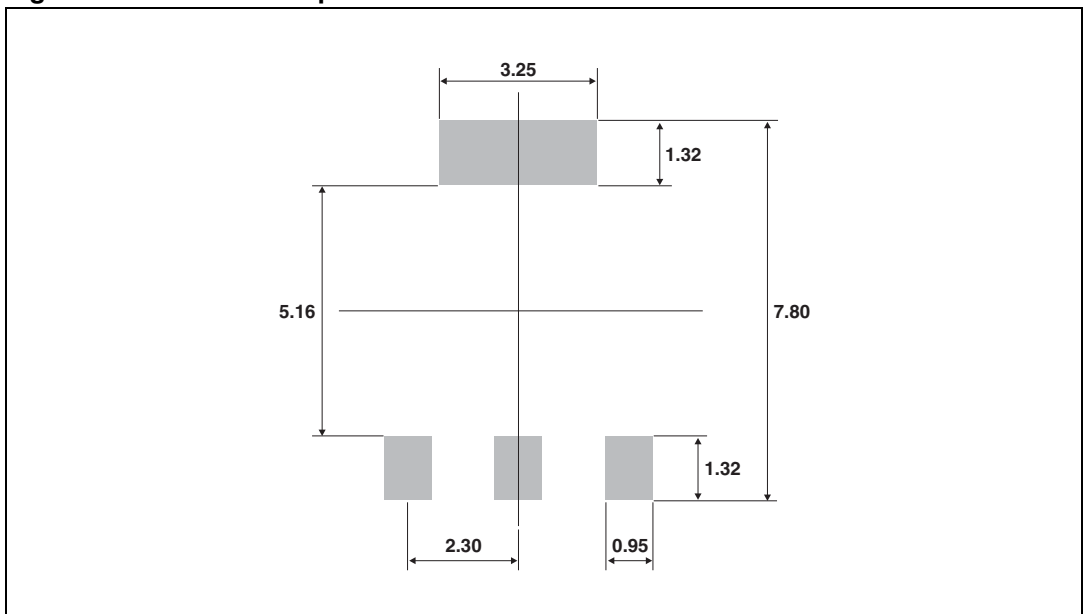



## 4 Ordering information

**Table 8. Ordering information**

Order code	Marking	Package	Weight	Base qty	Delivery mode
X00619MA1AA2	X0619 MA	TO-92	0.2 g	2500	Bulk
X00619MA2AL2				2000	Ammopack
X00619MA5AL2				2000	Tape and reel
X00619MN5AL2	X0 619 MN	SOT-223	0.12 g	1000	

## 5 Revision history

**Table 9. Document revision history**

Date	Revision	Changes
26-May-2009	1	First issue
03-May-2012	2	Added SOT-223 package.

**Please Read Carefully:**

Information in this document is provided solely in connection with ST products. STMicroelectronics NV and its subsidiaries ("ST") reserve the right to make changes, corrections, modifications or improvements, to this document, and the products and services described herein at any time, without notice.

All ST products are sold pursuant to ST's terms and conditions of sale.

Purchasers are solely responsible for the choice, selection and use of the ST products and services described herein, and ST assumes no liability whatsoever relating to the choice, selection or use of the ST products and services described herein.

No license, express or implied, by estoppel or otherwise, to any intellectual property rights is granted under this document. If any part of this document refers to any third party products or services it shall not be deemed a license grant by ST for the use of such third party products or services, or any intellectual property contained therein or considered as a warranty covering the use in any manner whatsoever of such third party products or services or any intellectual property contained therein.

**UNLESS OTHERWISE SET FORTH IN ST'S TERMS AND CONDITIONS OF SALE ST DISCLAIMS ANY EXPRESS OR IMPLIED WARRANTY WITH RESPECT TO THE USE AND/OR SALE OF ST PRODUCTS INCLUDING WITHOUT LIMITATION IMPLIED WARRANTIES OF MERCHANTABILITY, FITNESS FOR A PARTICULAR PURPOSE (AND THEIR EQUIVALENTS UNDER THE LAWS OF ANY JURISDICTION), OR INFRINGEMENT OF ANY PATENT, COPYRIGHT OR OTHER INTELLECTUAL PROPERTY RIGHT.**

**UNLESS EXPRESSLY APPROVED IN WRITING BY TWO AUTHORIZED ST REPRESENTATIVES, ST PRODUCTS ARE NOT RECOMMENDED, AUTHORIZED OR WARRANTED FOR USE IN MILITARY, AIR CRAFT, SPACE, LIFE SAVING, OR LIFE SUSTAINING APPLICATIONS, NOR IN PRODUCTS OR SYSTEMS WHERE FAILURE OR MALFUNCTION MAY RESULT IN PERSONAL INJURY, DEATH, OR SEVERE PROPERTY OR ENVIRONMENTAL DAMAGE. ST PRODUCTS WHICH ARE NOT SPECIFIED AS "AUTOMOTIVE GRADE" MAY ONLY BE USED IN AUTOMOTIVE APPLICATIONS AT USER'S OWN RISK.**

Resale of ST products with provisions different from the statements and/or technical features set forth in this document shall immediately void any warranty granted by ST for the ST product or service described herein and shall not create or extend in any manner whatsoever, any liability of ST.

ST and the ST logo are trademarks or registered trademarks of ST in various countries.

Information in this document supersedes and replaces all information previously supplied.

The ST logo is a registered trademark of STMicroelectronics. All other names are the property of their respective owners.

© 2012 STMicroelectronics - All rights reserved

STMicroelectronics group of companies

Australia - Belgium - Brazil - Canada - China - Czech Republic - Finland - France - Germany - Hong Kong - India - Israel - Italy - Japan - Malaysia - Malta - Morocco - Philippines - Singapore - Spain - Sweden - Switzerland - United Kingdom - United States of America

[www.st.com](http://www.st.com)