



life.augmented

Fundamentals of motor control

Industrial & Power conversion Training





Agenda

1 Basic principle

2 Brush DC motor

3 Three-phase brushless DC motor

4 Bipolar stepper motor

Basic principle



What an electric motor is

An electric motor is a device converting electrical energy into mechanical energy (generally a torque).

This conversion is usually obtained through the generation of a **magnetic field** by means of a current flowing into one or more coils.

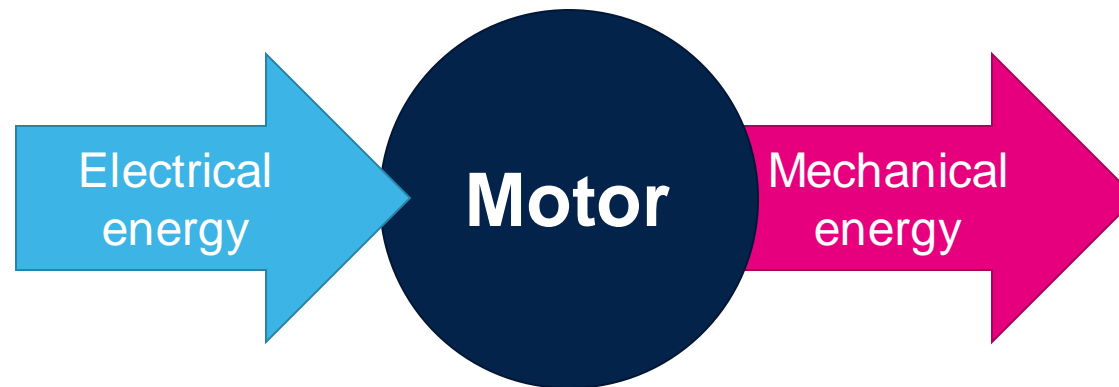



Rotor and stator magnetic fields

The rotation is obtained thanks to the attractive force between two magnetic fields:

- One field is located on the rotor (the moving part).
- The second magnetic field is located on the stator (the body of the motor).

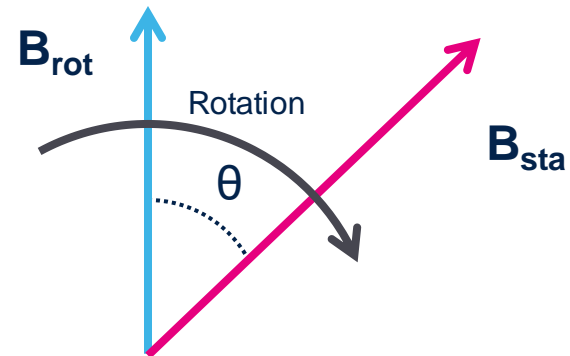

Usually one of the two is generated by a permanent magnet while the other one is generated through an electromagnet (solenoid).



Magnetic field generation

The relation between electrical energy (current) and magnetic field generated by a solenoid (coil) is obtained through the following formula:

$$B = k \cdot I_{ph}$$

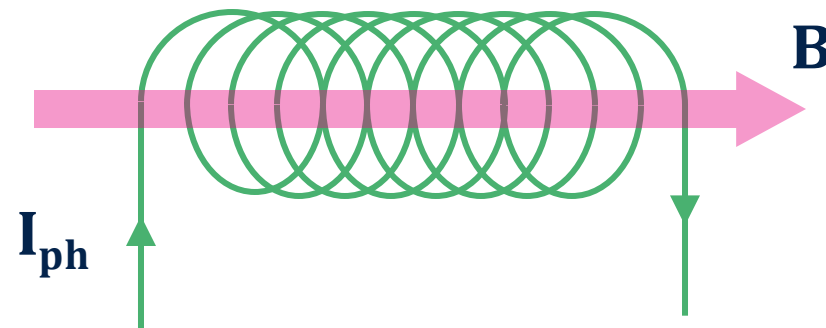

The **output torque** of an electrical motor depends on the intensity of the rotor and stator magnetic fields and on their phase relation:

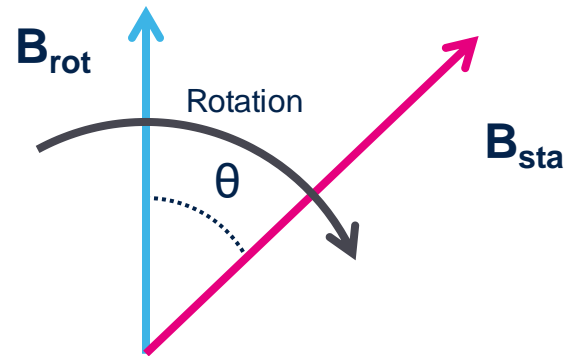

$$Tq \propto B_{rot} \cdot B_{sta} \cdot \sin(\theta) \propto I_{ph} \cdot \sin(\theta)$$

The angle θ between the two magnetic field is named **load angle**.

The maximum output torque, and then the **maximum efficiency**, is obtained when the **load angle is 90°**.

Back electro-motive force

The rotation of the rotor magnetic field (B_{rot}) causes a variation of the magnetic flux in the solenoid.

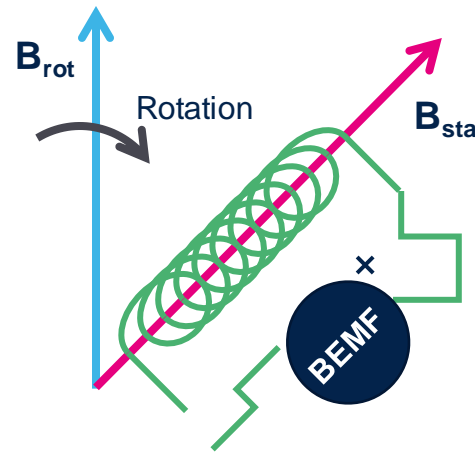

Consequently an electro-motive force facing the flux variation is generated (Lenz's law).

This effect is named **back electro-motive force** (aka **BEMF**) and it is proportional to the motor speed according to the formula:

$$V_{BEMF} = k_e \cdot Speed$$



Basic principle

The electric motor operation is based on the following points:

- At least one of the two **magnetic field** is generated by a solenoid carrying a current.
- **Phase relation** between the rotor and stator magnetic field (i.e. the load angle) must be always greater than 0° in order to keep the motor in motion (negative angles reverse the rotation).
- Output **torque** depends to both solenoid **current** and **load angle**.
- Motor rotation causes a **back electro-motive** force opposing the motion itself.



Inductive load

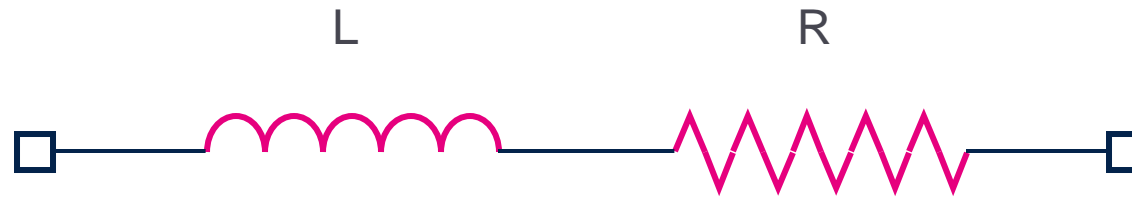

An inductive load (motor phases included) can be represented as an LR series which stores energy in the form of current.

Applying a voltage to the load it is possible to change the amount of current stored into the inductance.



Charge and discharge of an inductive load

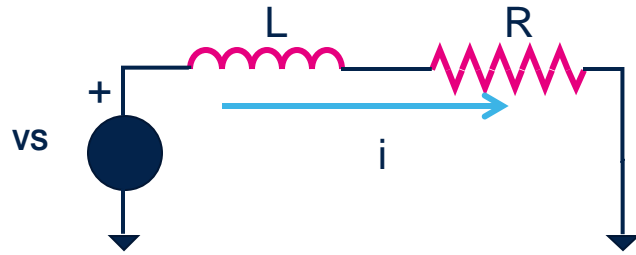

Scenario 1 (ON time)

Inductance is charged applying a voltage:

$$i(t) = \frac{V_S}{R} + \left(i(0) - \frac{V_S}{R} \right) \cdot e^{-t \cdot R/L}$$

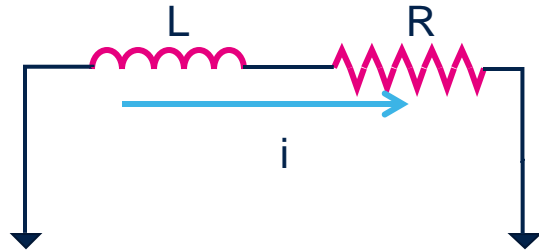

Scenario 2 (slow decay)

Inductance is discharged shorting the leads:

$$i(t) = i(0) \cdot e^{-t \cdot R/L}$$

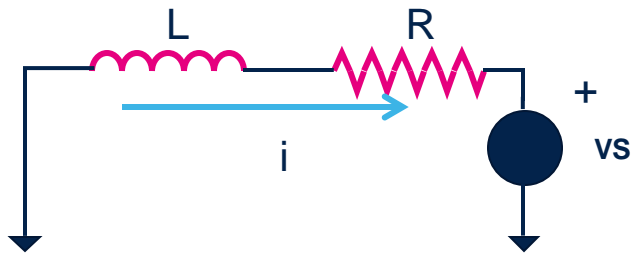

Scenario 3 (fast decay)

Inductance is discharged applying a voltage:

$$i(t) = -\frac{V_S}{R} + \left(i(0) + \frac{V_S}{R} \right) \cdot e^{-t \cdot R/L}$$

The most common method to control the current is the **fixed OFF time** method.

It is a **closed-loop** approach which implies the measurement of the controlled current.

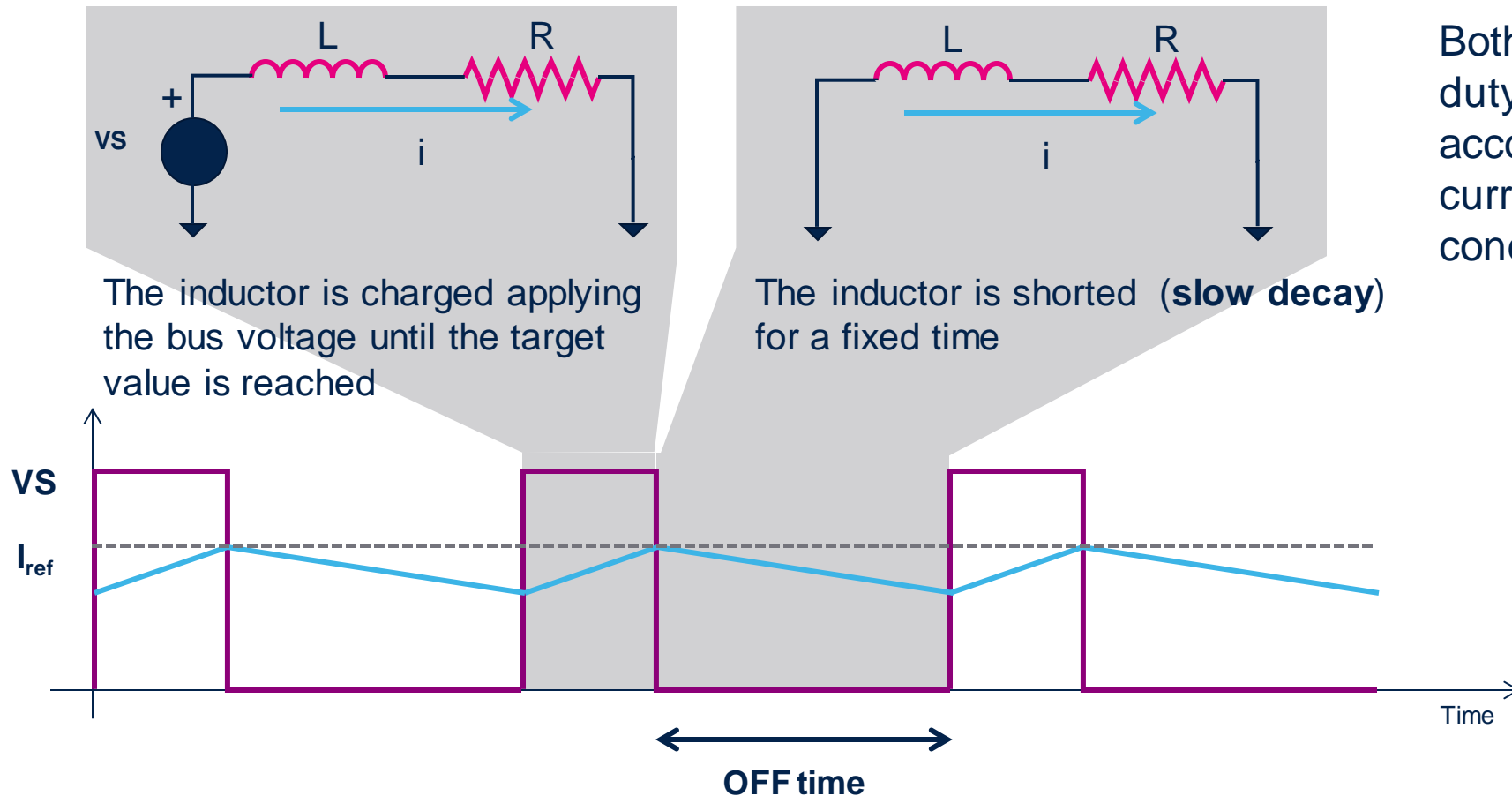

Both PWM frequency and duty-cycle changes according to the target current and boundary conditions.

How to read the load current?

When the low side switch is ON, the load's current flows through the resistor positioned in-between the low side and the ground

The resulting voltage drop is proportional to the current:

$$V_{SENSE} = i_{load} \cdot R_{SENSE}$$

This resistor is named **shunt resistor** or **sense resistor**

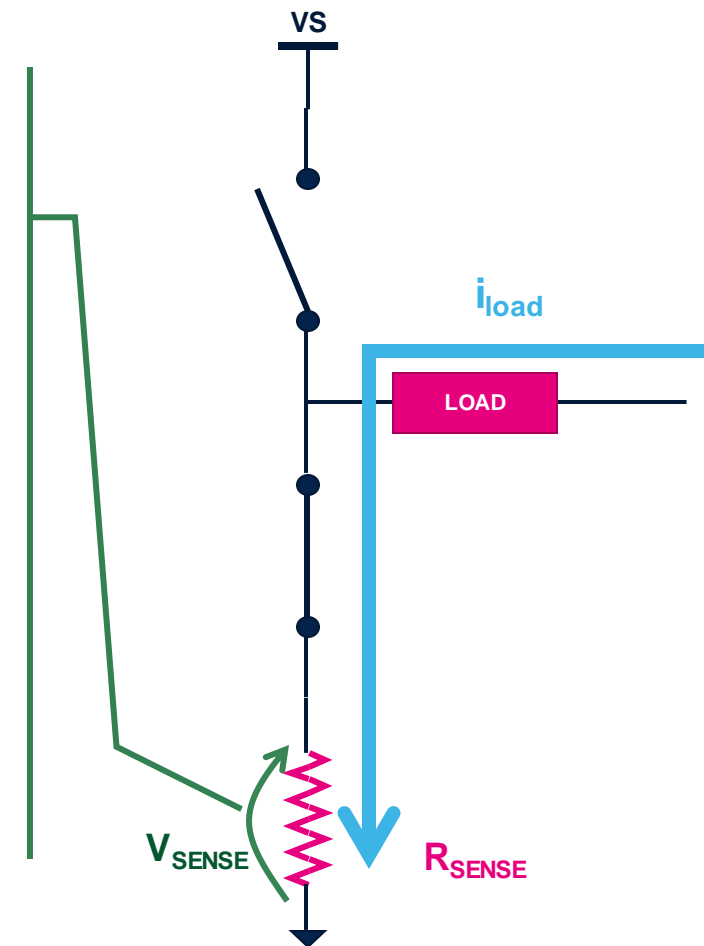

Current control sensing

According to the current direction the drop on the sense resistor can be both positive or negative.

Reading negative voltages requires specific signal conditioning circuitry.

The simplest current control algorithms senses the current in one direction only

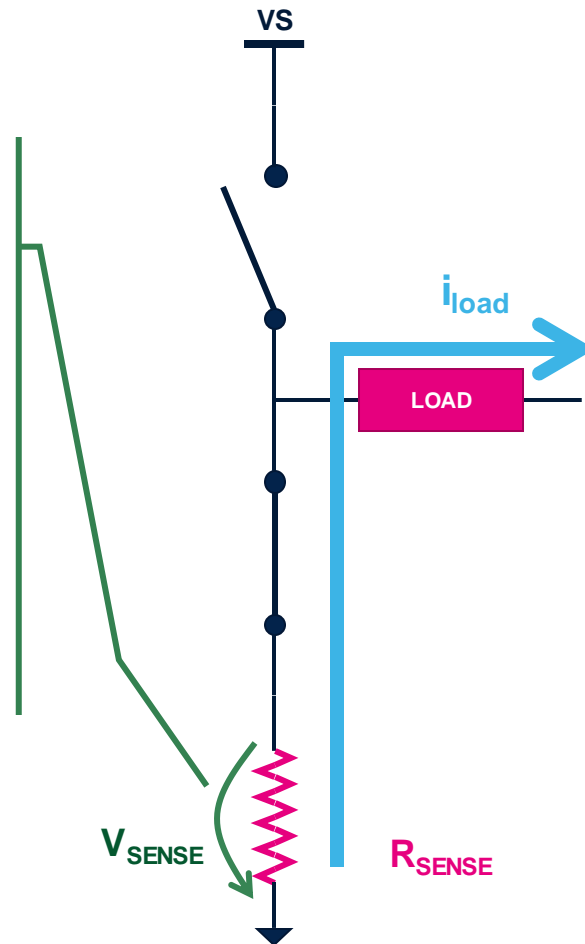

In some cases, the current doesn't flow into the shunt resistor even if the low side switch is on.

$$V_{SENSE} = 0$$

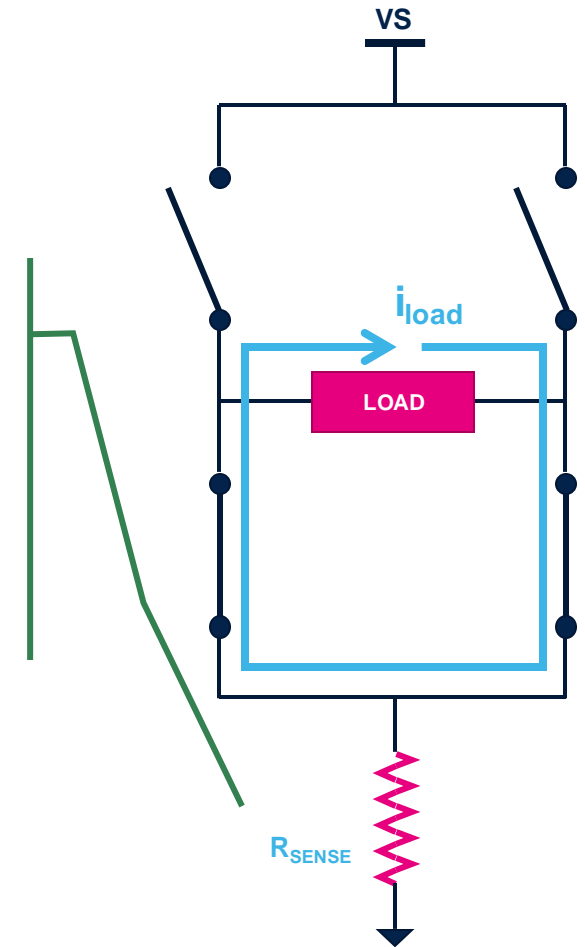

Back EMF effects on current control

The **back electromotive force** can change the behavior of the system

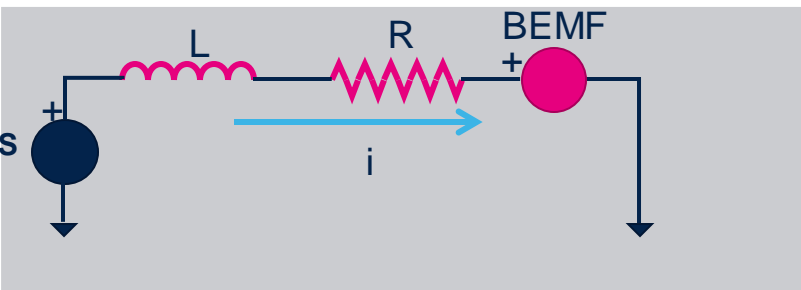
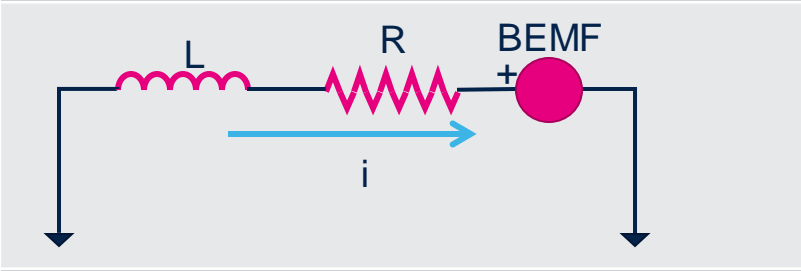
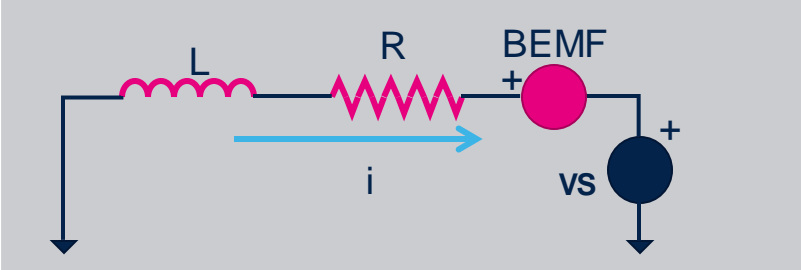
Scenario	BEMF > 0	BEMF < 0
	<p>The BEMF slows the current increase because it opposes to the VS voltage</p>	<p>The BEMF is added to the VS to increase the current</p>
	<p>The BEMF increases the current drop</p>	<p>The BEMF reduces the current drop</p>
	<p>The BEMF is added to the VS to decrease the current</p>	<p>The BEMF opposes to the VS voltage slowing the current drop</p>

Brush DC motor



Basics - mechanical

The rotor coils are sequentially connected to the motor leads through mechanical switches (brushes)

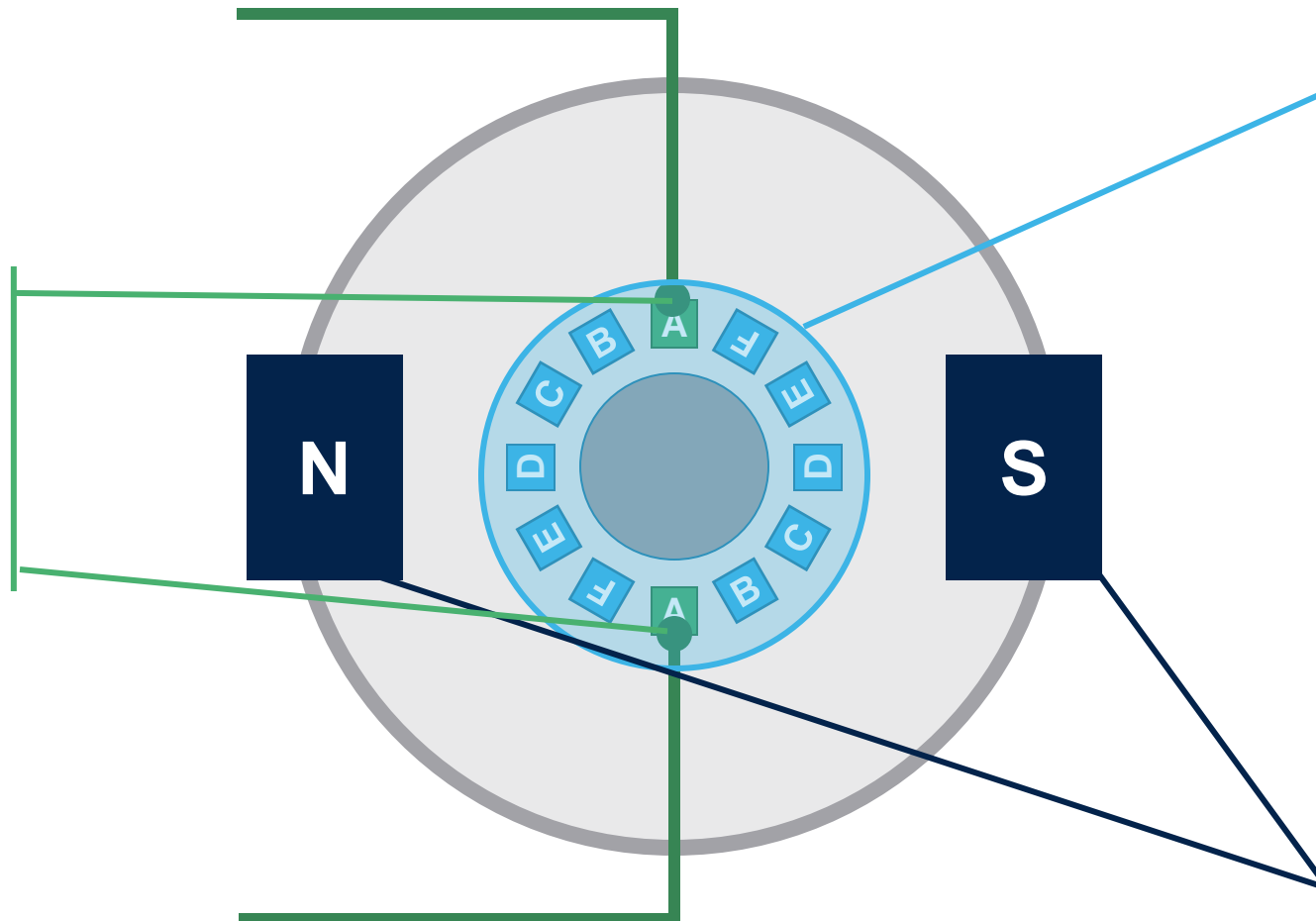

The rotor is composed by a group of coils

The stator magnetic field is generated by a permanent magnet

Basics – magnetic fields and load angle

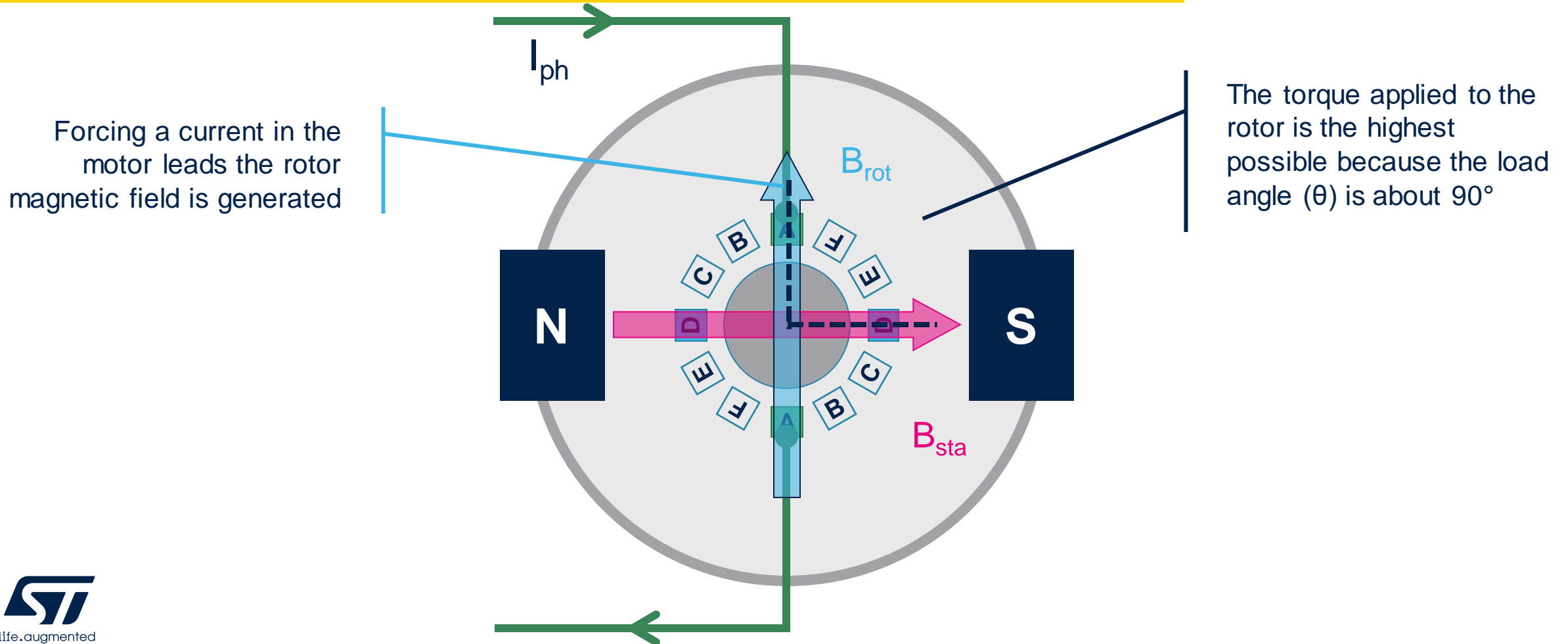

Basics – brushes and rotation

The brushes connect the motor leads to the next coil (**B**) keeping the load angle almost equal to 90° during rotation

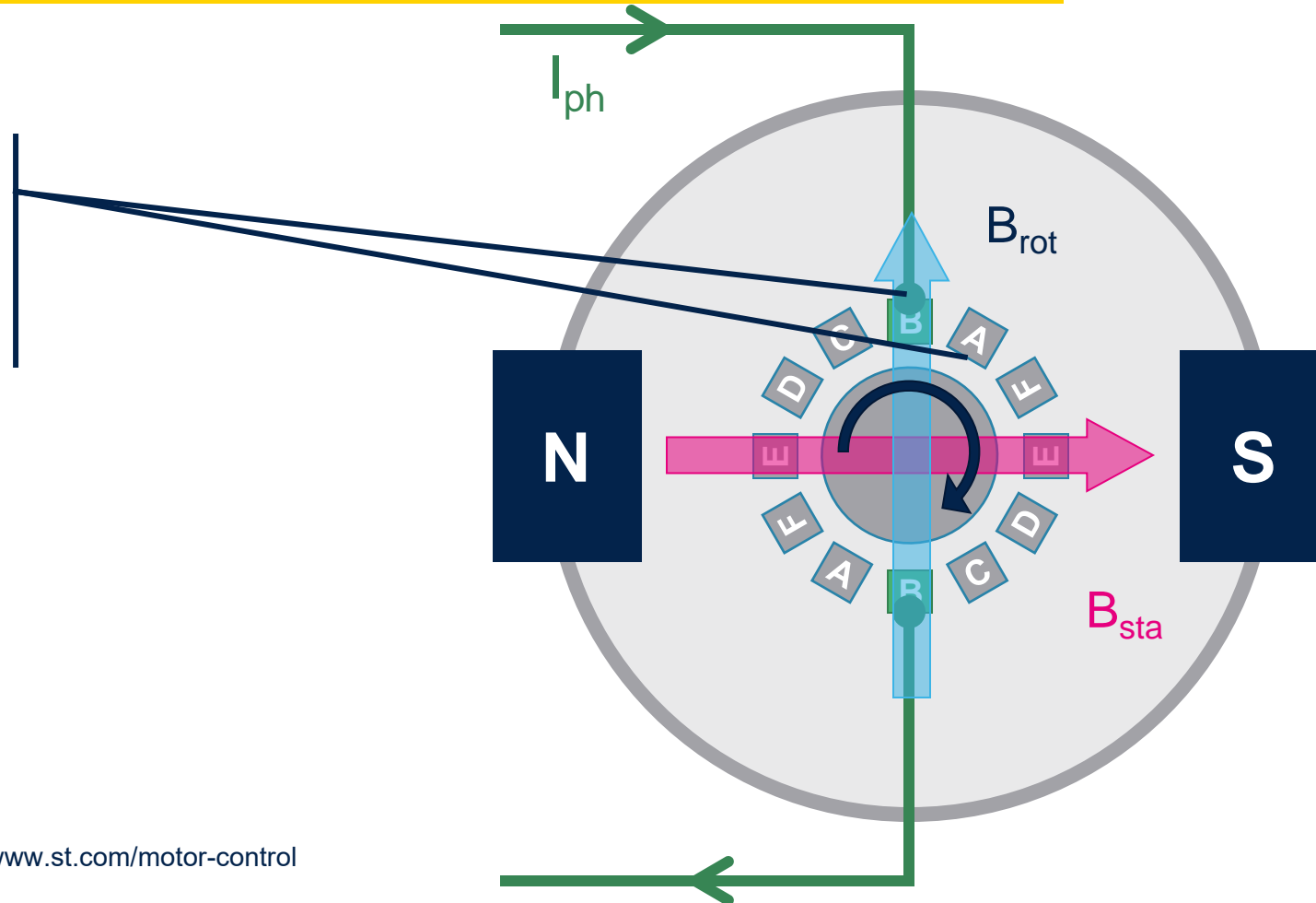

Basics – reverse rotation

Changing the current direction the motor rotation is reversed

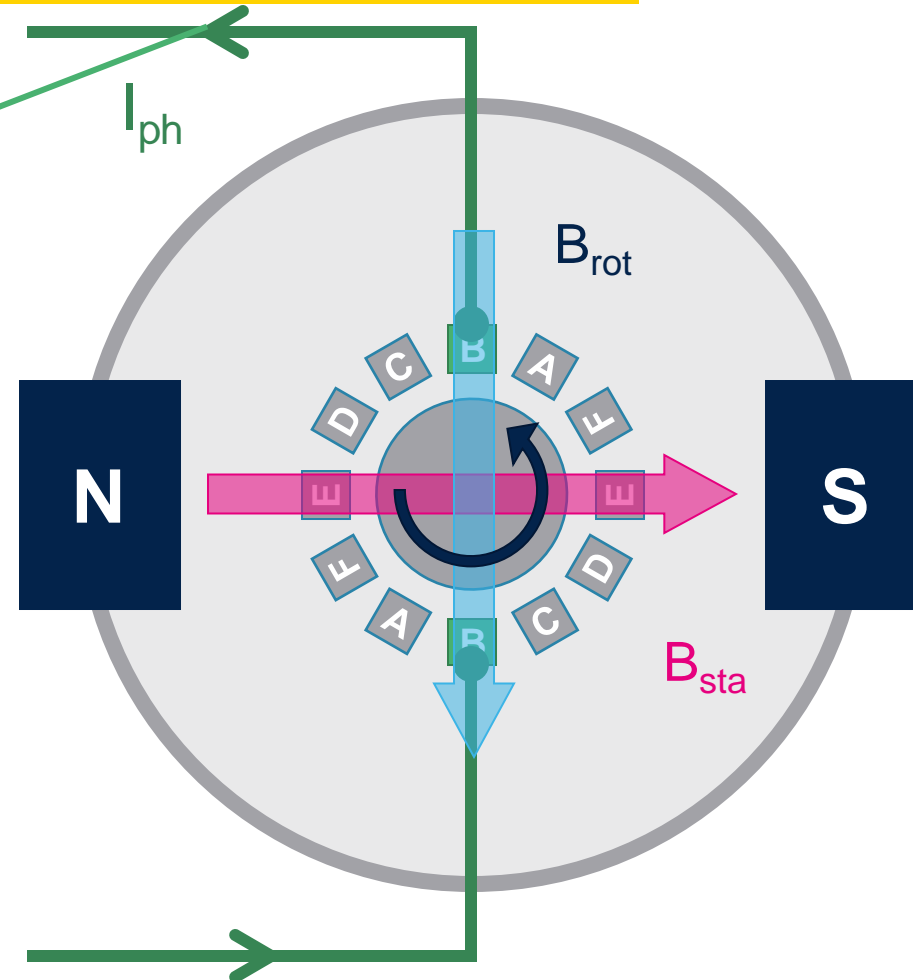

Basics – electrical model

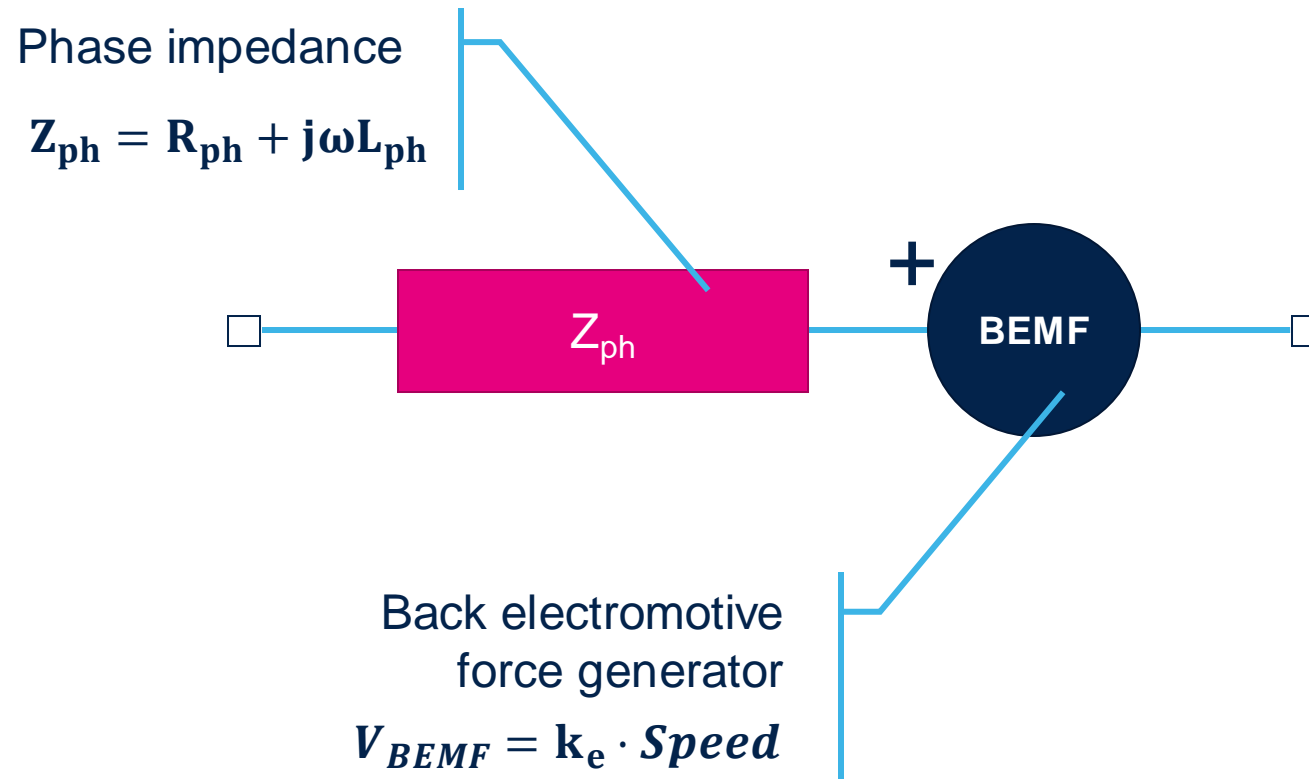

Voltage mode driving

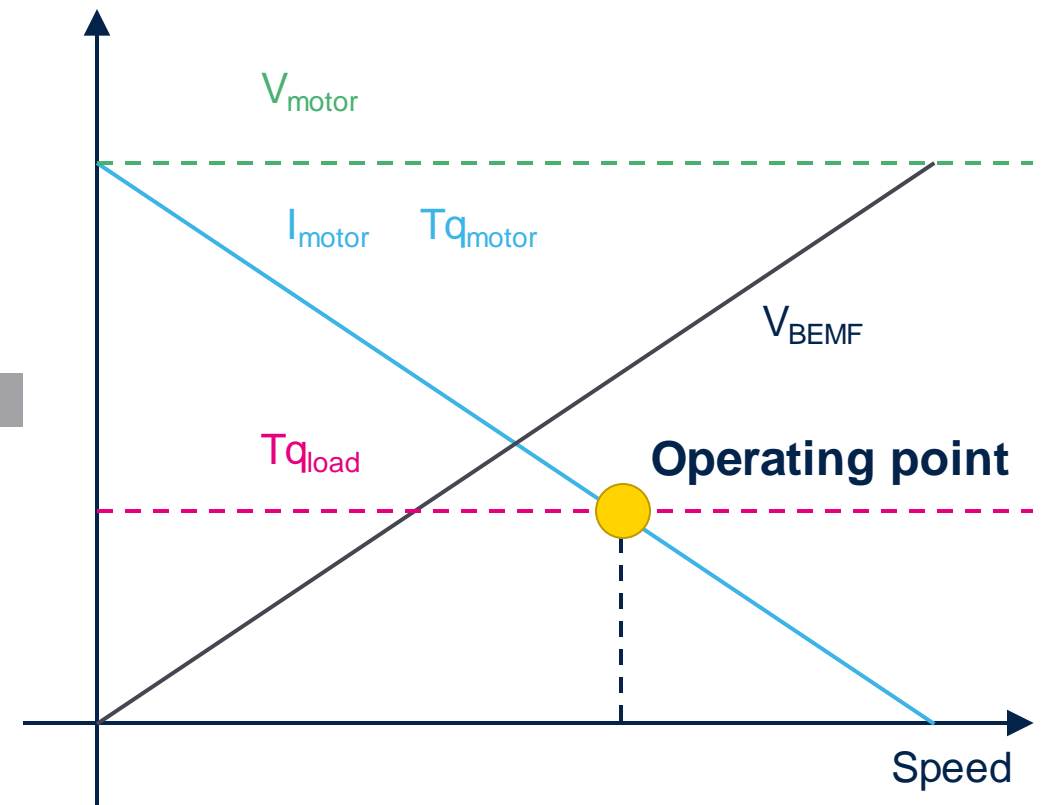
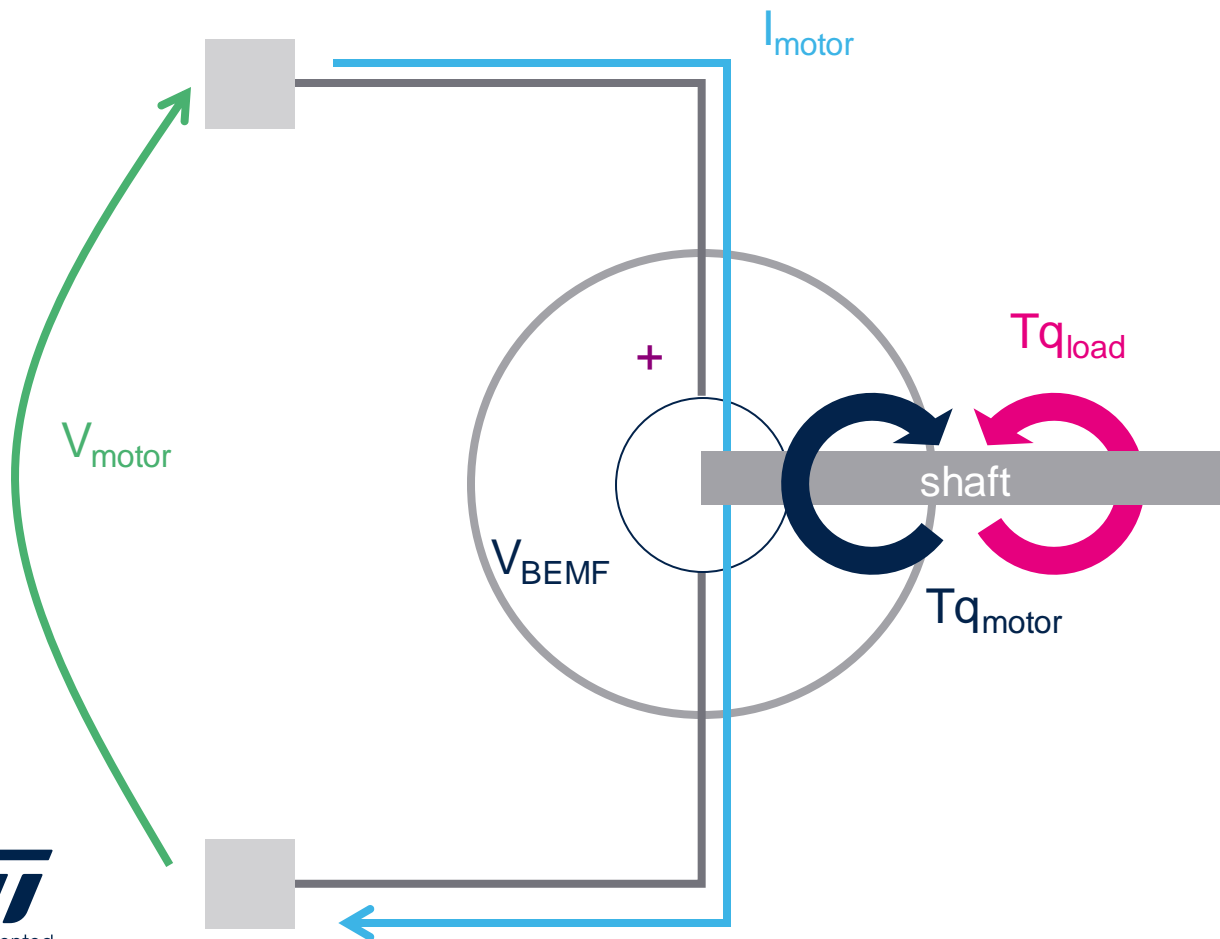

Extending maximum operating speed

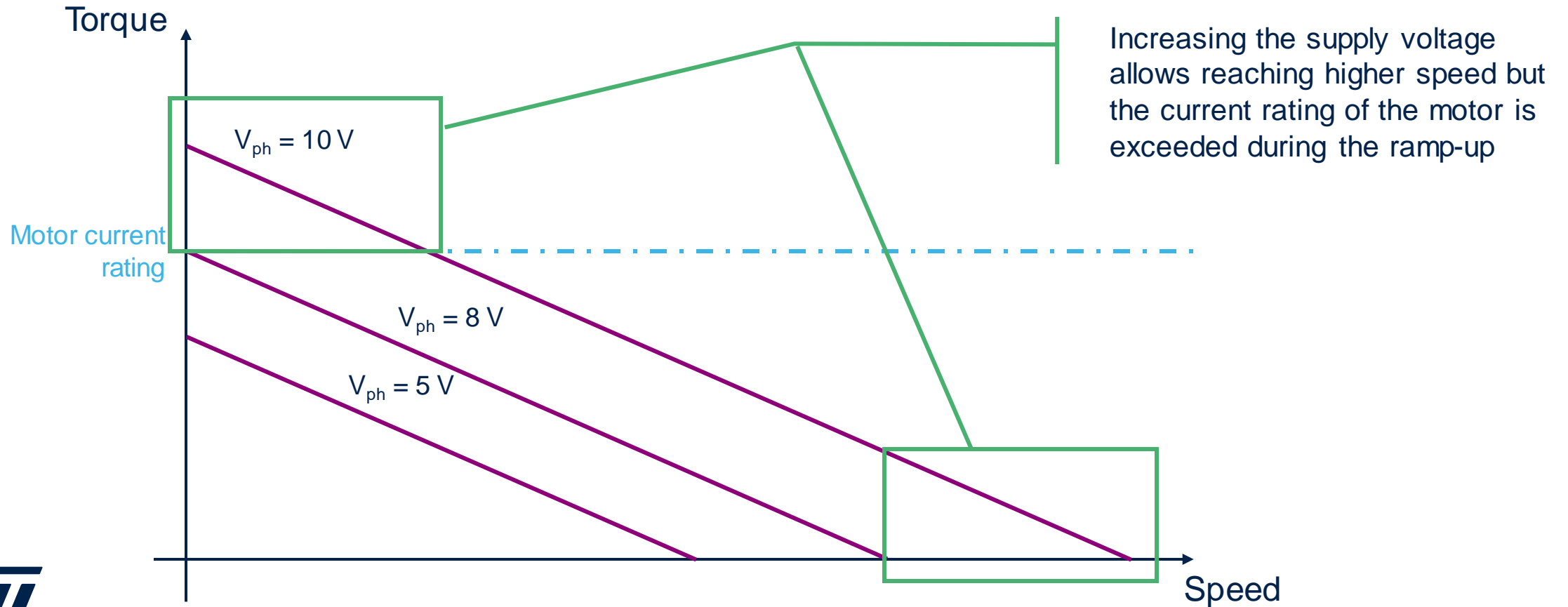

Extending maximum operating speed with current limiter

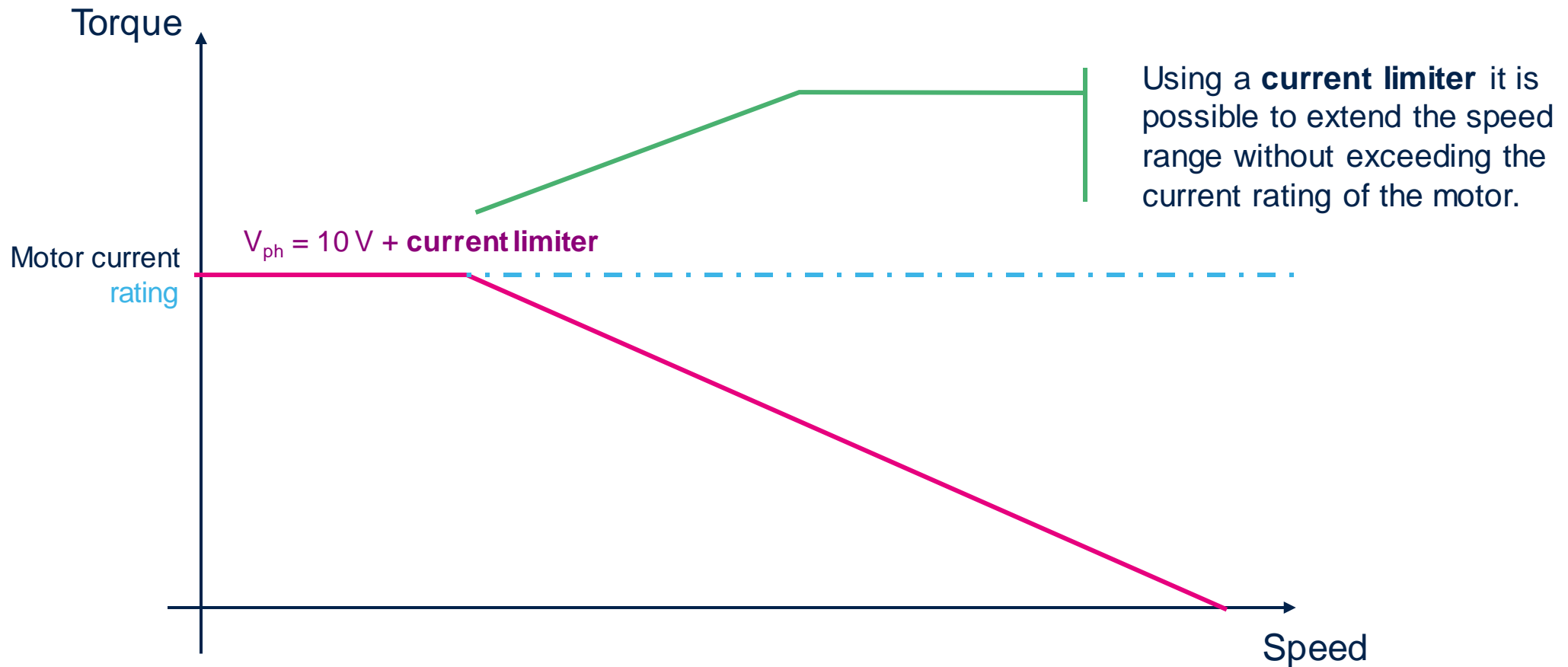



Brush DC motor summary

- The magnetic field intensity is proportional to the current forced into the motor leads.
- The magnetic field rotation is automatically obtained commutating the active coil through mechanical switches (brushes).
- The load angle is almost constant, and it is about 90° allowing the maximum efficiency (current vs. torque proportion).
- The motor is controlled applying a voltage on the motor leads. The higher the voltage, the higher the speed. The direction is changed reversing the polarity on the leads.
- The **maximum torque** is limited by the current rating of the motor and it is obtained at zero speed (start-up).
- The **maximum speed** is limited by the supply voltage and it is obtained when no load torque is present.



Three-phase brushless DC motor





Brushless DC motors overview

There are different types of brushless motors:

- Single phase
- Two phase
- **Three phase**

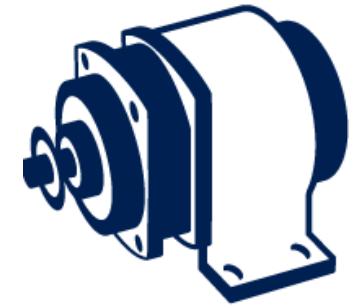

The presentation will describe the basics of the **three-phase brushless motor** because it is the most common version.

Anyway most of the considerations can be extended to the other types.

Three-phase brushless DC motor

Basics - mechanical

The stator is composed by three coils, named **phases**, positioned at 120° from each other

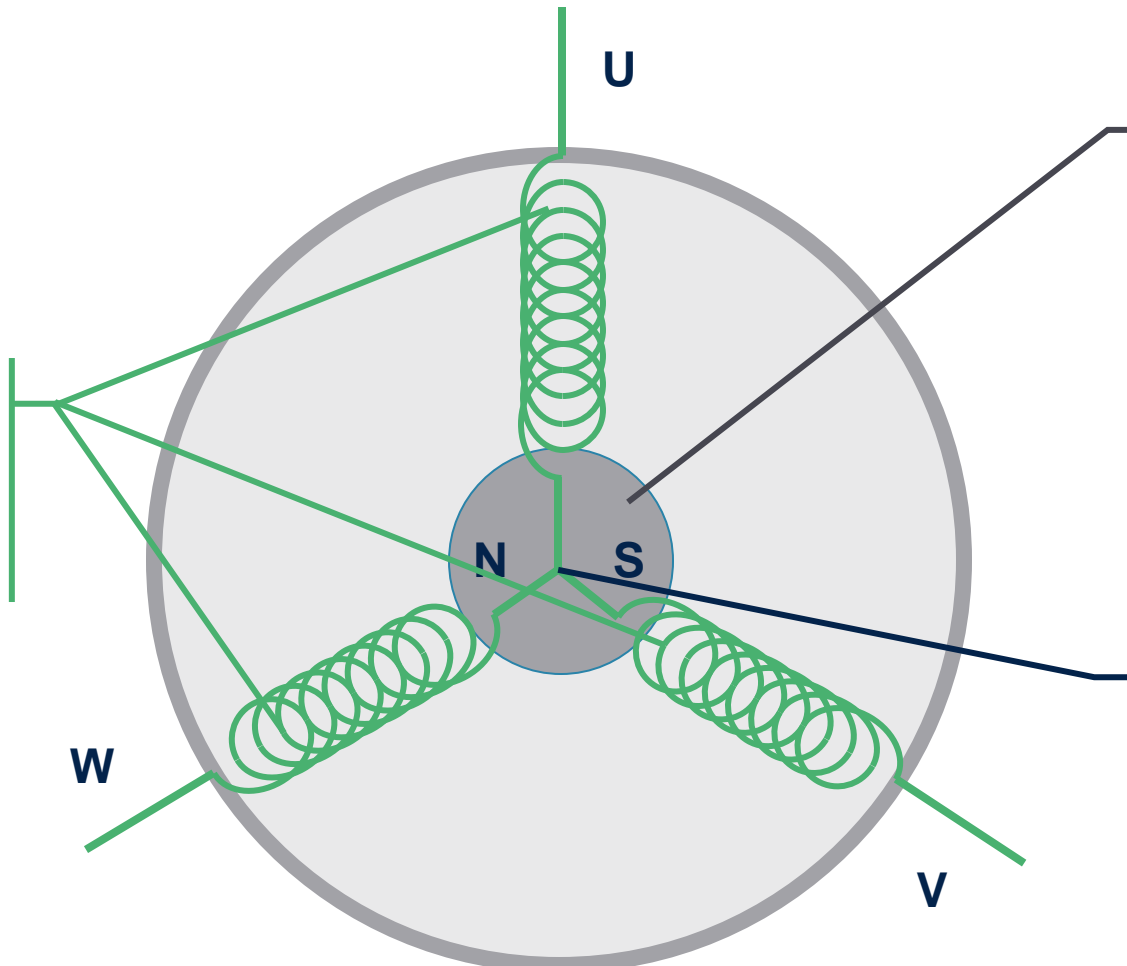

A permanent magnet generates the magnetic field of the rotor

The windings are connected by one of the sides. The sum of the currents is zero

Basics – magnetic fields

The **rotor magnetic field** is always present, and it is generated by a permanent magnet.

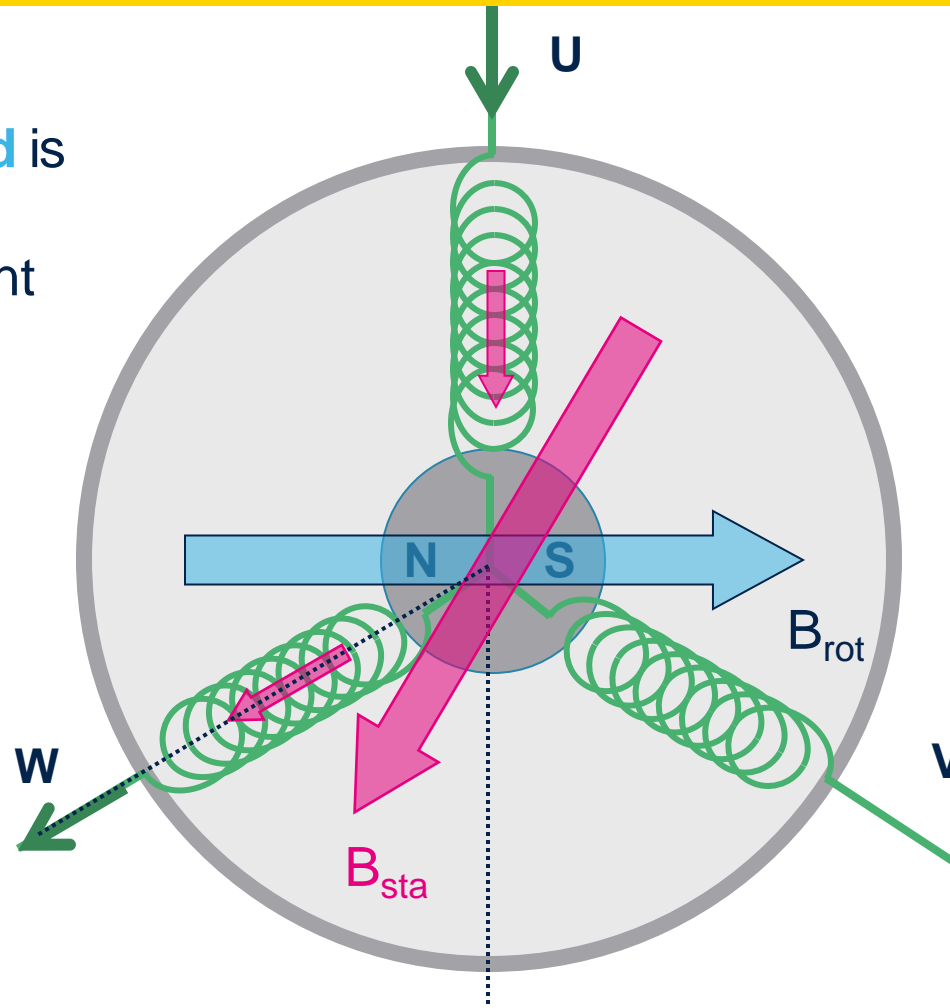

When a current flows from a motor phase to another one the magnetic fields are combined generating the **stator field**.

Basics – load angle and rotation

The torque applied to the motor is proportional to the sine of the **load angle** (θ).

When the rotor magnetic field approaches the stator one, the torque is reduced.

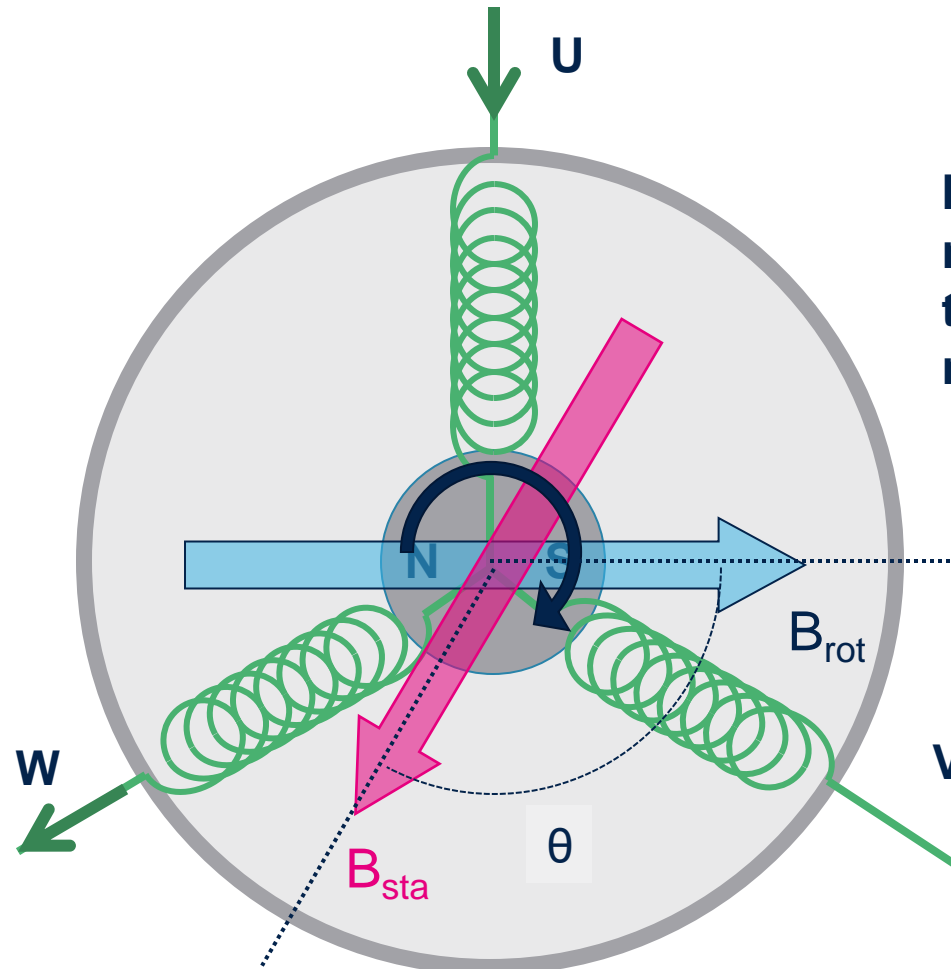

In order to keep the motor in motion it is necessary to change the direction of the stator magnetic field.

Basics – electrical model

Phase impedance
 $Z_{ph} = R_{ph} + j\omega L_{ph}$

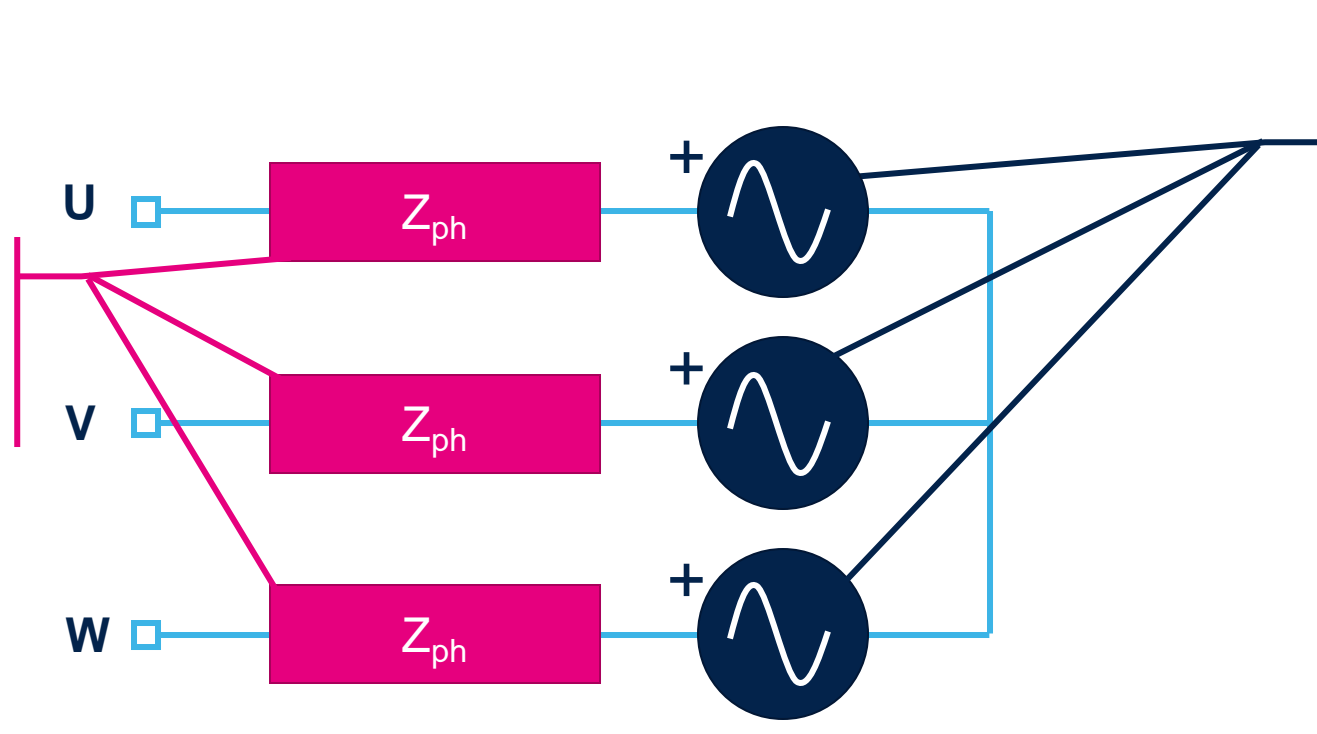

Back electromotive force generators. BEMFs are three sinewave voltages^(*) delayed from each other by 120°.

The sinewave amplitude is proportional to the motor speed:

$$V_{BEMF} = k_e \cdot \text{Speed}$$

(*) Some motors have a BEMF with trapezoidal shape instead of sinusoidal

6-step driving – rotor position

The **6-step driving** imposes a current between two of the three phases leaving the third one floating.

In this way the stator magnetic field can be positioned in **6 discrete directions**.

The scanning of the 6 driving combinations of the six step is synchronized by the **rotor position**.

The rotor position can be monitored through Hall sensors or using a BEMF sensing technique (sensorless)

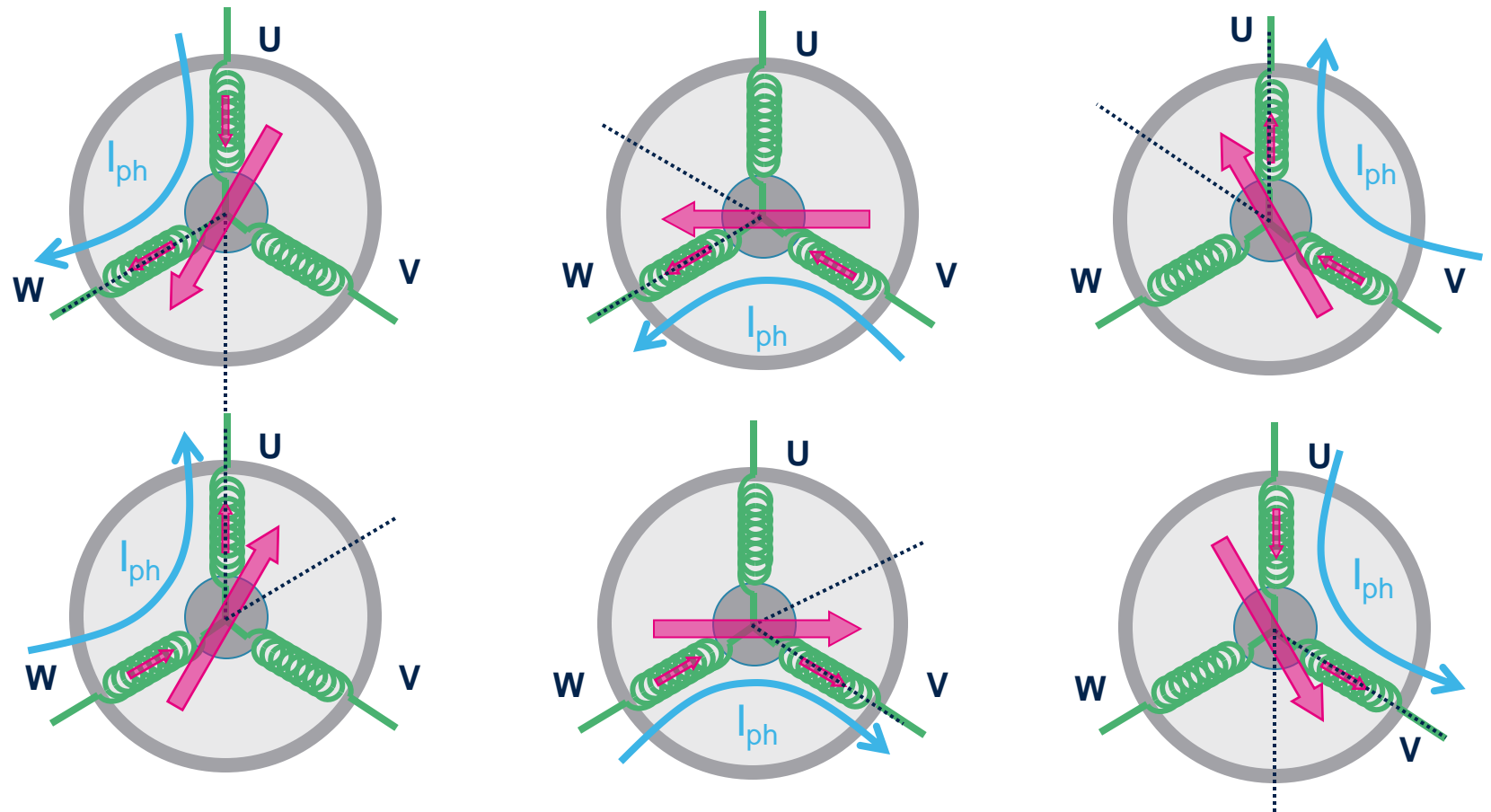



Three-phase brushless DC motor

6-step driving – Hall sensors feedback

The **Hall sensors** detects the rotor position returning a digital or analog signal. The information is used to move the stator magnetic field in the next position.

Rotor position	Stator position	Current
1	A	$U \rightarrow W$
2	B	$V \rightarrow W$
3	C	$V \rightarrow U$
4	D	$W \rightarrow U$
5	E	$W \rightarrow V$
6	F	$U \rightarrow V$

NOTE: Clockwise rotation

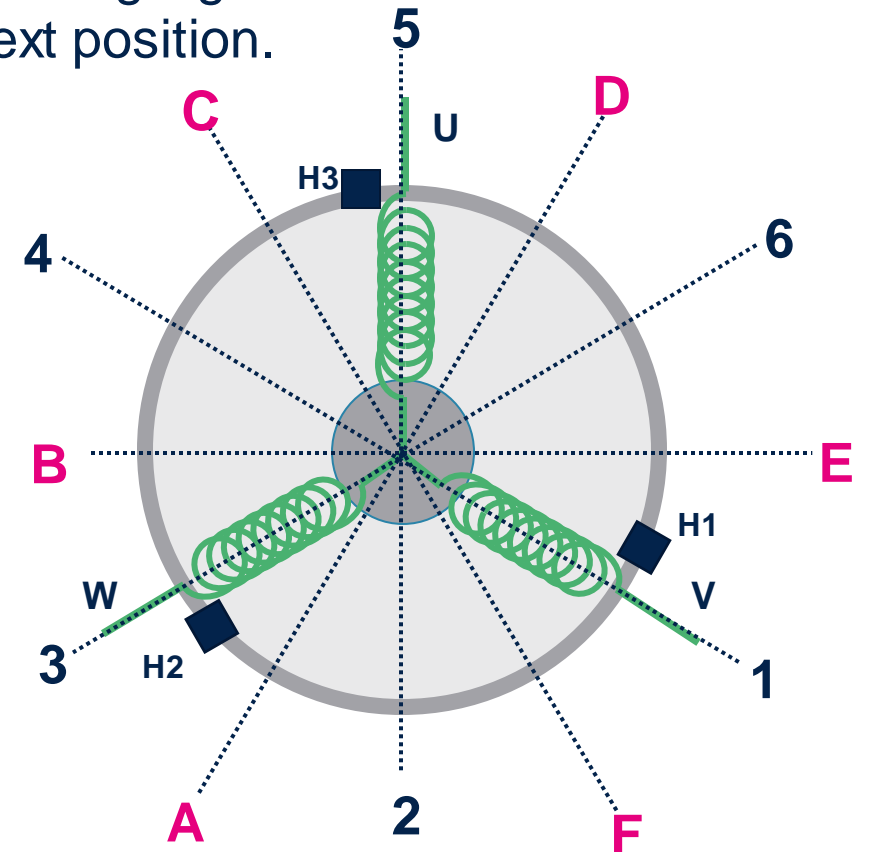



Three-phase brushless DC motor

6-step driving – current waveforms

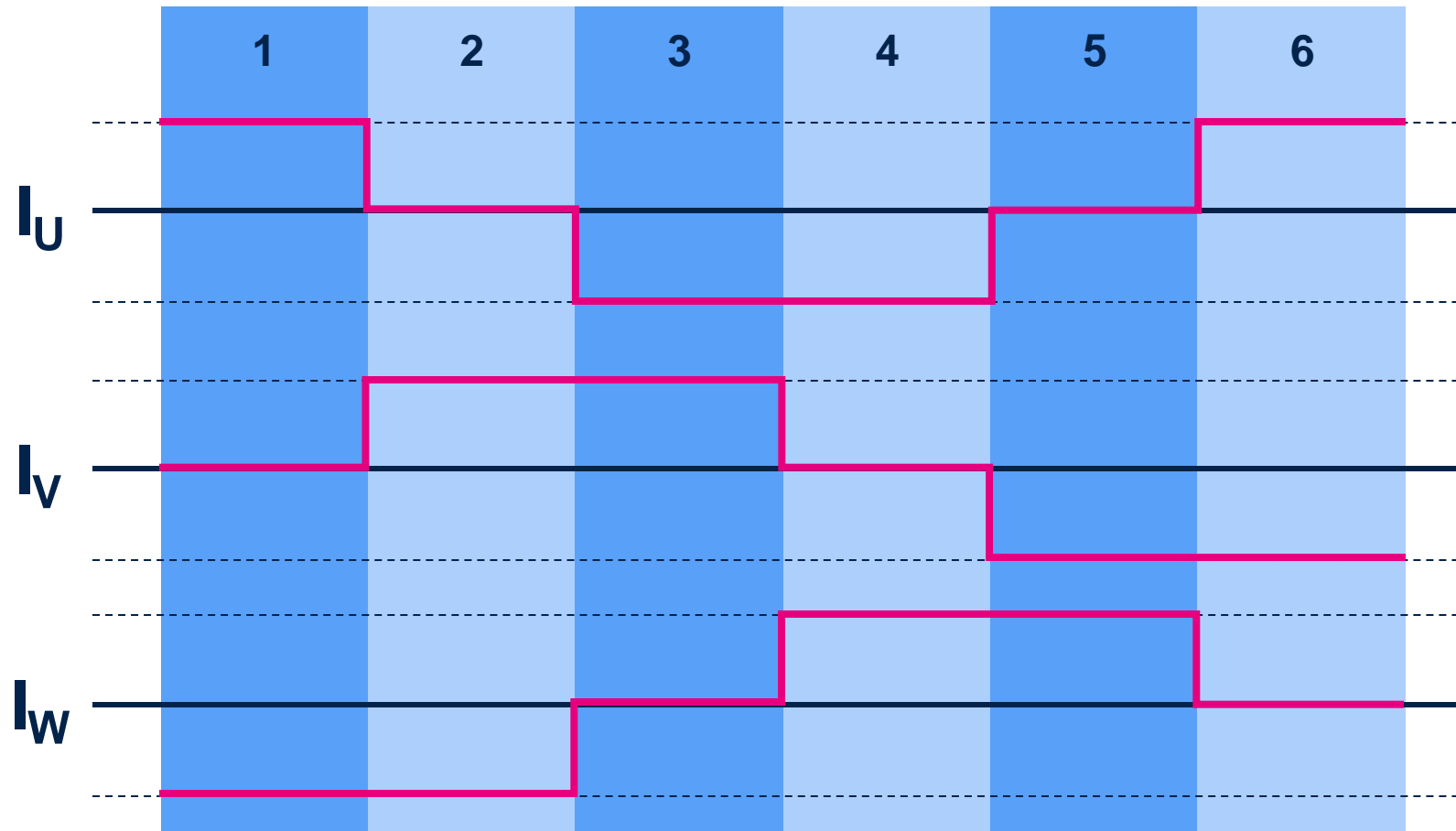

6-step driving – sensorless driving

The sensorless driving detects the BEMF zero-crossing measuring the voltage on the floating phase.

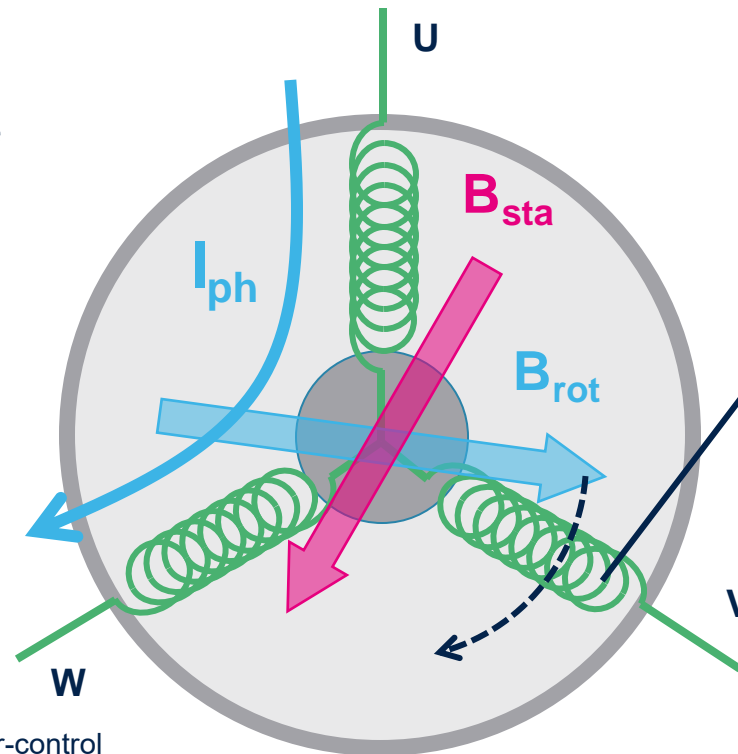

When the magnetic field of the rotor crosses the unloaded phase, the respective BEMF voltage changes polarity (zero-crossing)

Three-phase brushless DC motor

6-step driving – electrical model

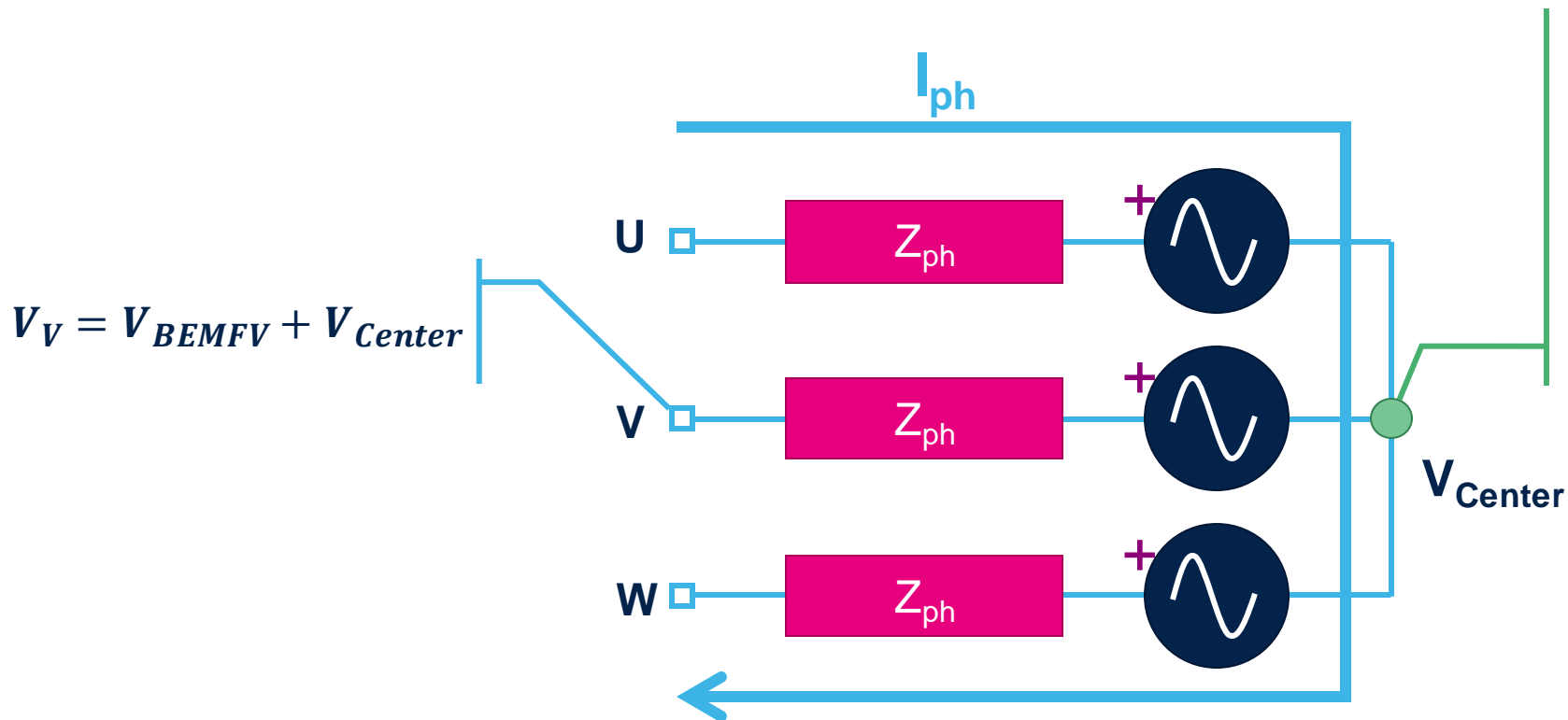

In order to detect the zero-crossing of the BEMF the center-tap voltage must be known.

Some motors makes the center tap available. In other cases it can be reconstructed through the phase voltages.

Field Oriented Control

The **Field Oriented Control (FOC)** algorithm allows to obtain the maximum performance from a BLDC motor.

The objective of the algorithm is to control the vector components of the stator magnetic field (i.e. the phase currents) in order to obtain the target **intensity** and **phase relation** with the rotor magnetic field.

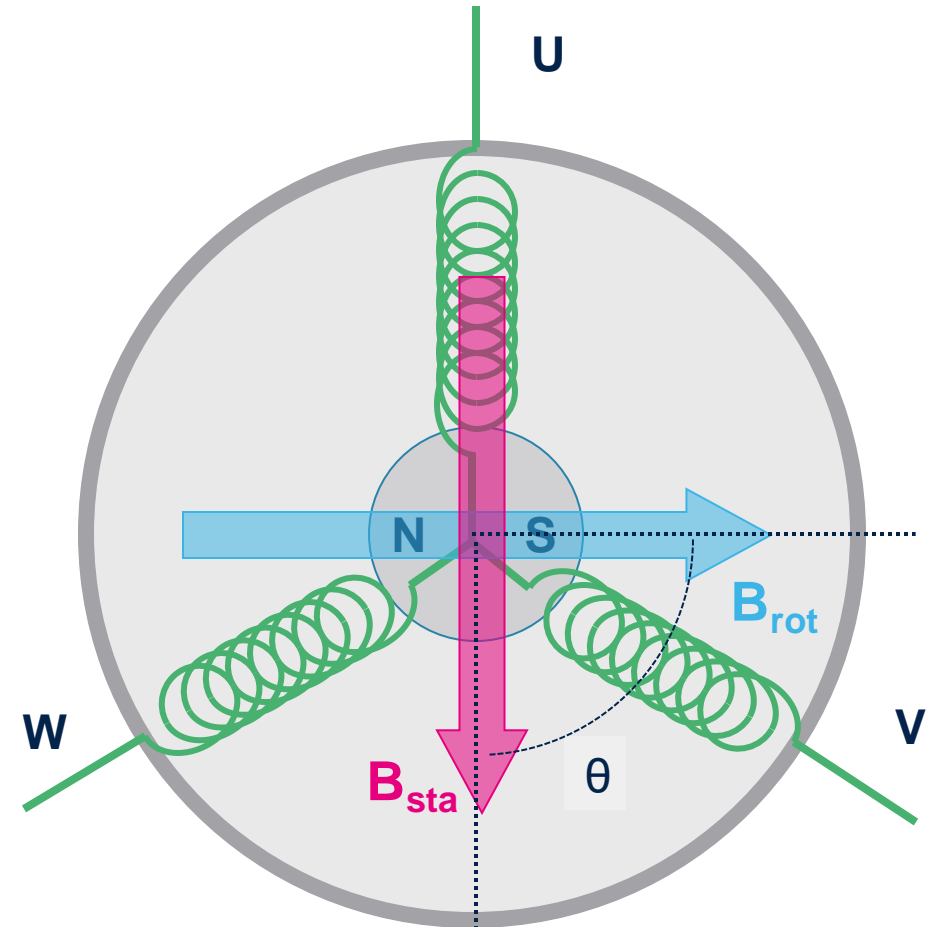



Three-phase brushless DC motor

Field Oriented Control – block diagram

The **Field Oriented Control (FOC)** can be represented through this block diagram

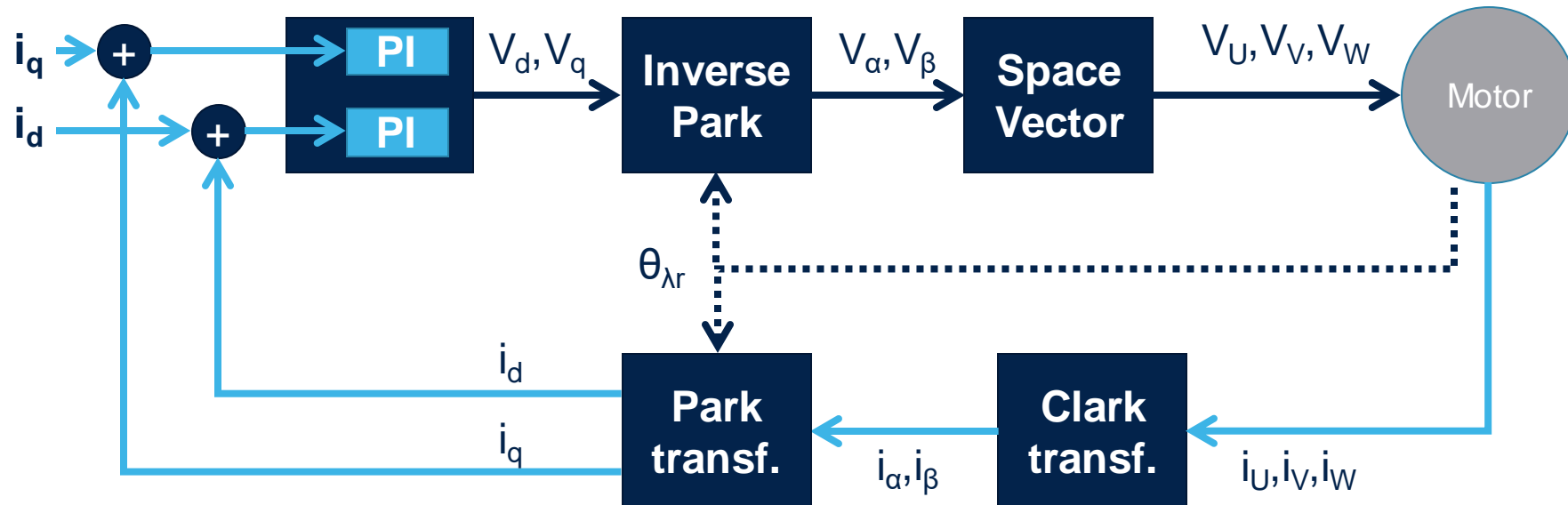



Three-phase brushless DC motor

Field Oriented Control – pro & cons

Pros

- Can control the **efficiency** of the system imposing a **load angle** (direct component of the current)
- **Smooth operation** thanks to the sinusoidal driving

Cons

- Implies **complex calculations** which cannot be performed by low level microcontrollers
- Needs the **information** of the rotor flux (i.e. expensive sensors or more complex calculations)



Three-phase brushless DC motor summary

- The stator magnetic field is the combination of the magnetic fields generated by the motor phases.
- The magnetic field rotation is obtained driving in the proper way the phases.
- The position of the rotor must be sensed in order to determine the proper driving sequence.

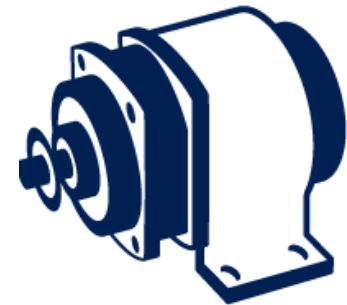

Bipolar stepper motor





Stepper motor overview

There are different types of stepper motors:

- Unipolar (two phases)
- **Bipolar (two phases)**
- Three phase
- Five phase



The presentation will describe the basics of the **bipolar stepper motor** because it is one of the most common version.

Anyway most of the considerations can be extended to the other types.

Basics - mechanical

The stator is composed by two coils, named **phases**, positioned at 90° from each other

The stepper motors are designed to **keep a target angular position**. This objective is obtained splitting the rotation of the shaft in small fractions named **steps**.

Each step represent a stable position where the motor shaft can be easily kept forcing the proper current into the phases.

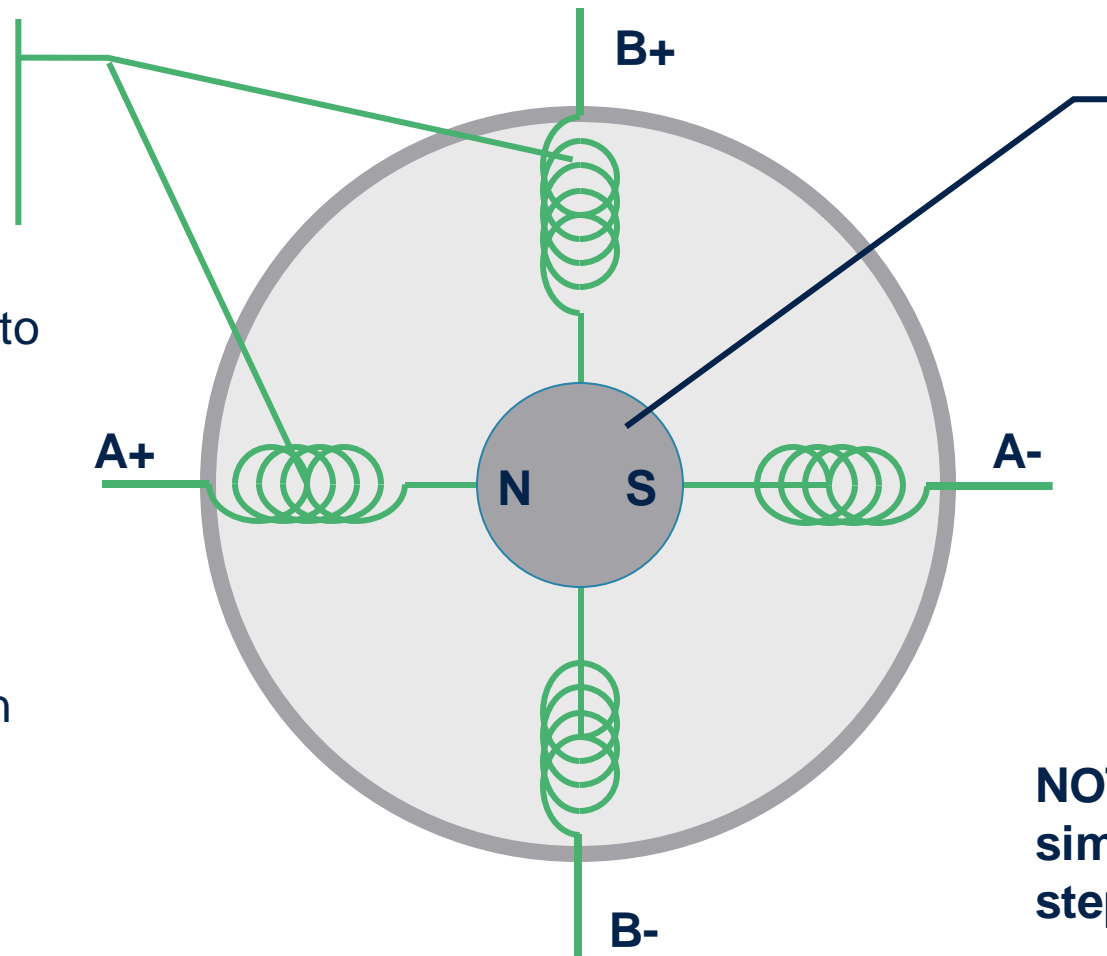

A permanent magnet generates the magnetic field of the rotor

NOTE: This is the simplified model of a 4 step/round stepper motor

Basics - Magnetic fields and step position

The rotor magnetic field is always present, and it is generated by a permanent magnet.

The stator magnetic field is generated forcing a current in one phase.

The rotor will align to the stator magnetic field: **the target step position is achieved.**

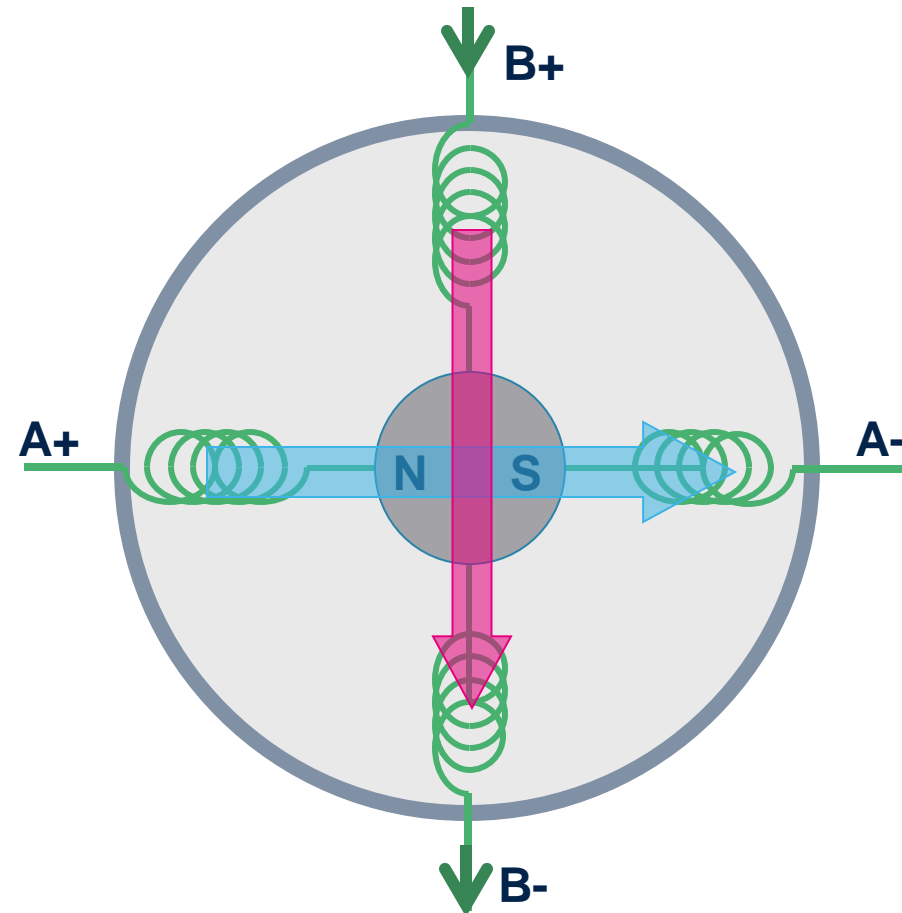



Bipolar stepper motor

Basics – step angle

In stepper motors a complete rotation of the stator magnetic field (i.e. a sequence of **four steps**) does not correspond to a complete mechanical rotation.

This effect is obtained through a proper shaping of the rotor and stator cores: consequently **at each position of the magnetic field more mechanical positions correspond**.

$$\text{Step angle} = \frac{360}{\text{poles} \times \text{phases}} = \frac{360}{N_{STEP}}$$

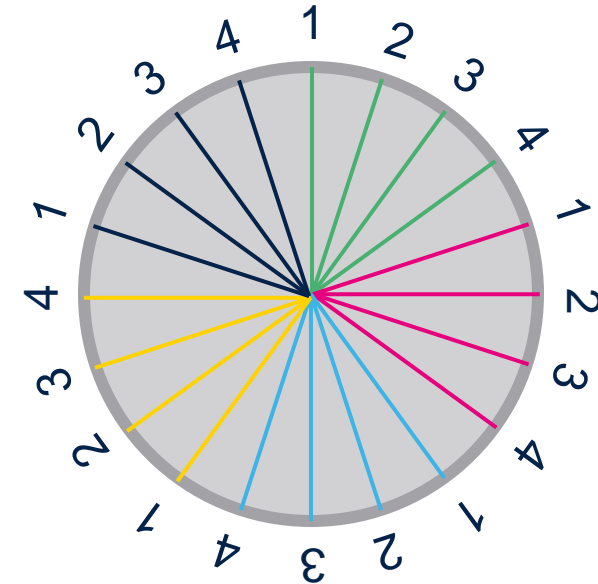

Example: in a 20 steps stepper motor each full step combination (numbered from 1 to 4) can position the rotor at 5 possible angles (colors)



Bipolar stepper motor

Basics - rotations

The phases have always to be driven following the **proper sequence**, otherwise the motor rotation cannot be achieved.

The stepper motor is moved performing a series of small rotations, i.e. the **steps**. This way the mechanical position of the shaft is always known without the need for a dedicated position sensor (*).

The motor speed is determined by the frequency at which the sequence is performed, and it is expressed in **steps per second** or **pulses per second (pps)**.



Basics – electrical model

Phase impedance

$$Z_{ph} = R_{ph} + j\omega L_{ph}$$

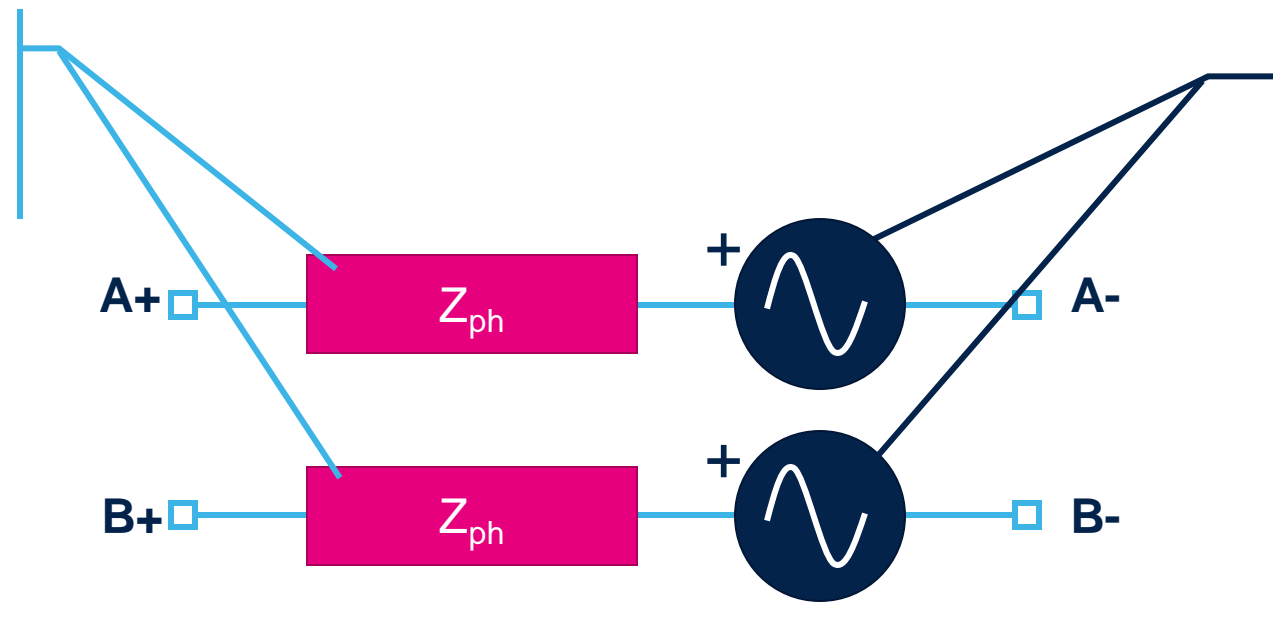

Back electromotive force generator. BEMF are two sinewave voltages^(*) delayed from each other by 90°. The sinewave amplitude is proportional to the motor speed:

$$V_{BEMF} = k_e \cdot Speed$$

Full-step wave mode

Forcing the phase currents according to the following sequence, the motor rotates performing one step at a time.

This is named
Full-step 1 phase on
 driving or
Full-step wave mode

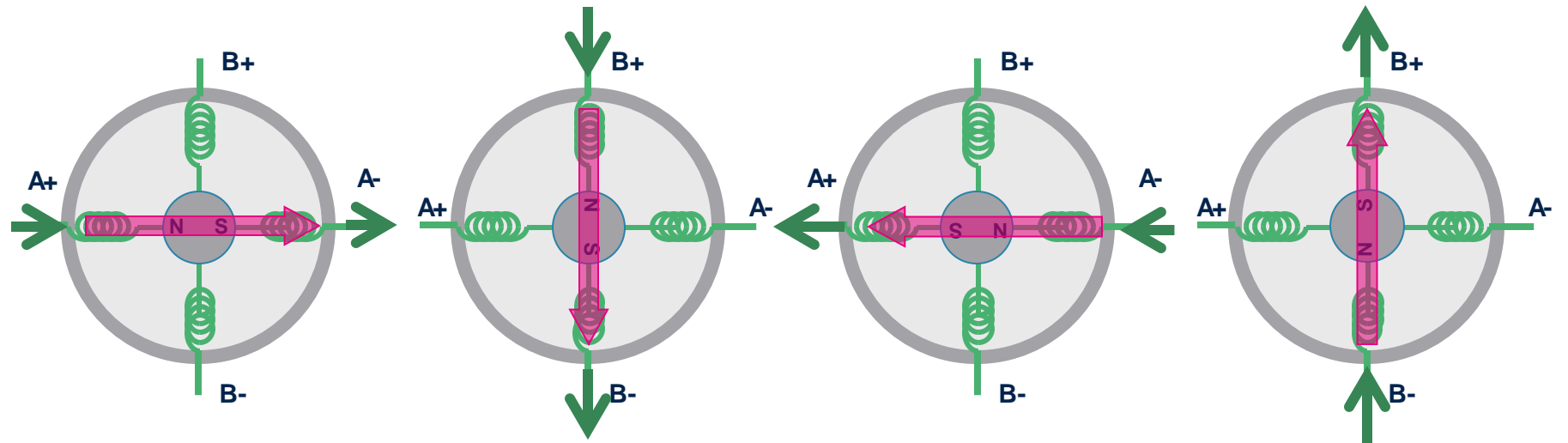

1	2	3	4
$I_{phA} = +$	$I_{phA} = 0$	$I_{phA} = -$	$I_{phA} = 0$
$I_{phB} = 0$	$I_{phB} = +$	$I_{phB} = 0$	$I_{phB} = -$

Full-step normal mode

It is also possible to perform the sequence forcing the same current in both the phases. In this case the stator magnetic field is the geometric sum of two components and is $\sqrt{2}$ times stronger.

This is named
Full-step 2 phase on driving or
Full-step normal mode

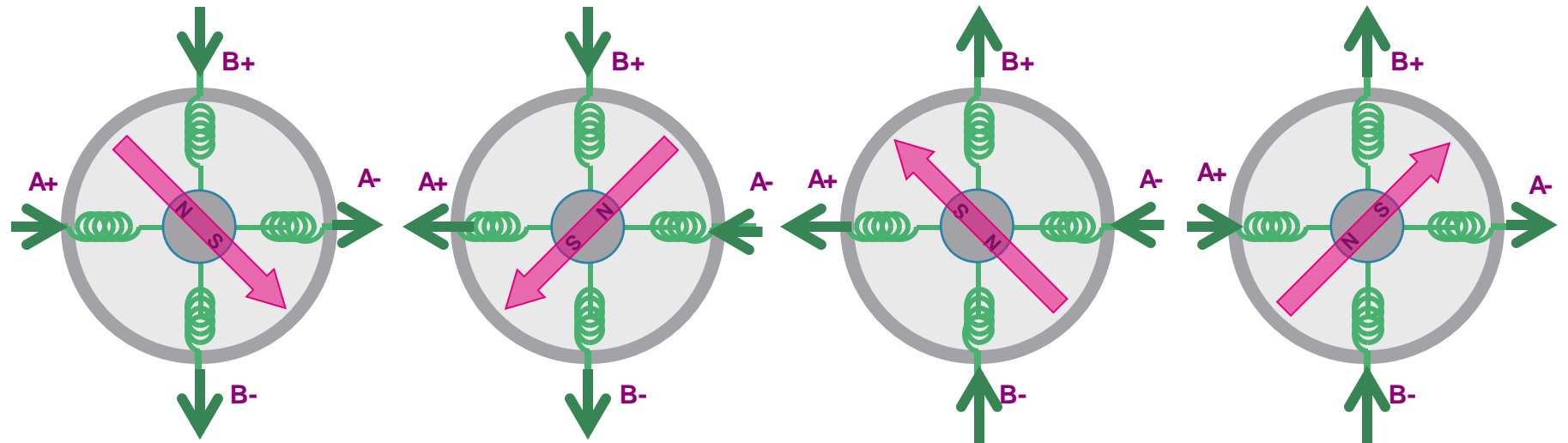

1b	2b	3b	4b
$I_{phA} = +$	$I_{phA} = -$	$I_{phA} = -$	$I_{phA} = +$
$I_{phB} = +$	$I_{phB} = +$	$I_{phB} = -$	$I_{phB} = -$

Half step

Combining the two driving methods it is possible to position the rotor in middle position between two subsequent steps.

Half-step is performed.

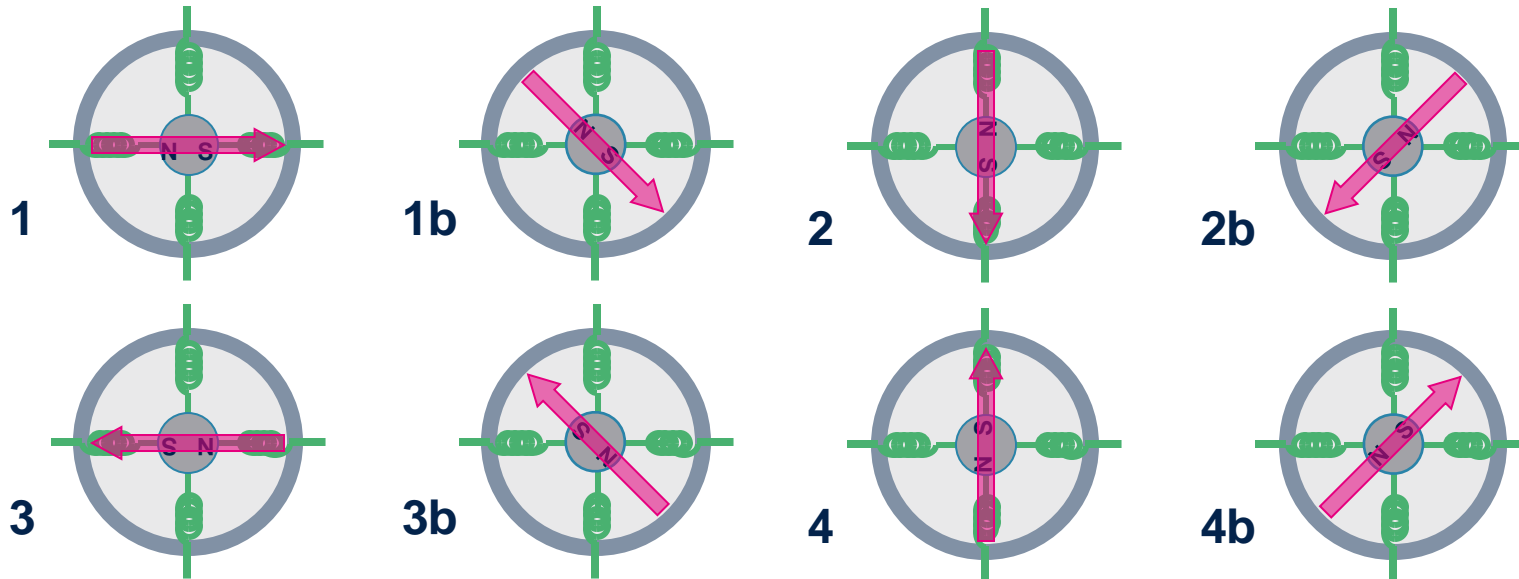

This method **doubles the number of mechanical positions** achievable by the motor.

1ph ON	2ph ON	Half-step
1		1
	1b	1b
2		2
	2b	2b
3		3
	3b	3b
4		4
	4b	4b

Microstepping

Starting from half-step concept, it is possible to further increase the number of stable mechanical position using the **microstepping** technique.

Each position of the rotor can be achieved applying the proper pair of currents to the phases.

This pair is determined by the sine and cosine values of the target angle.

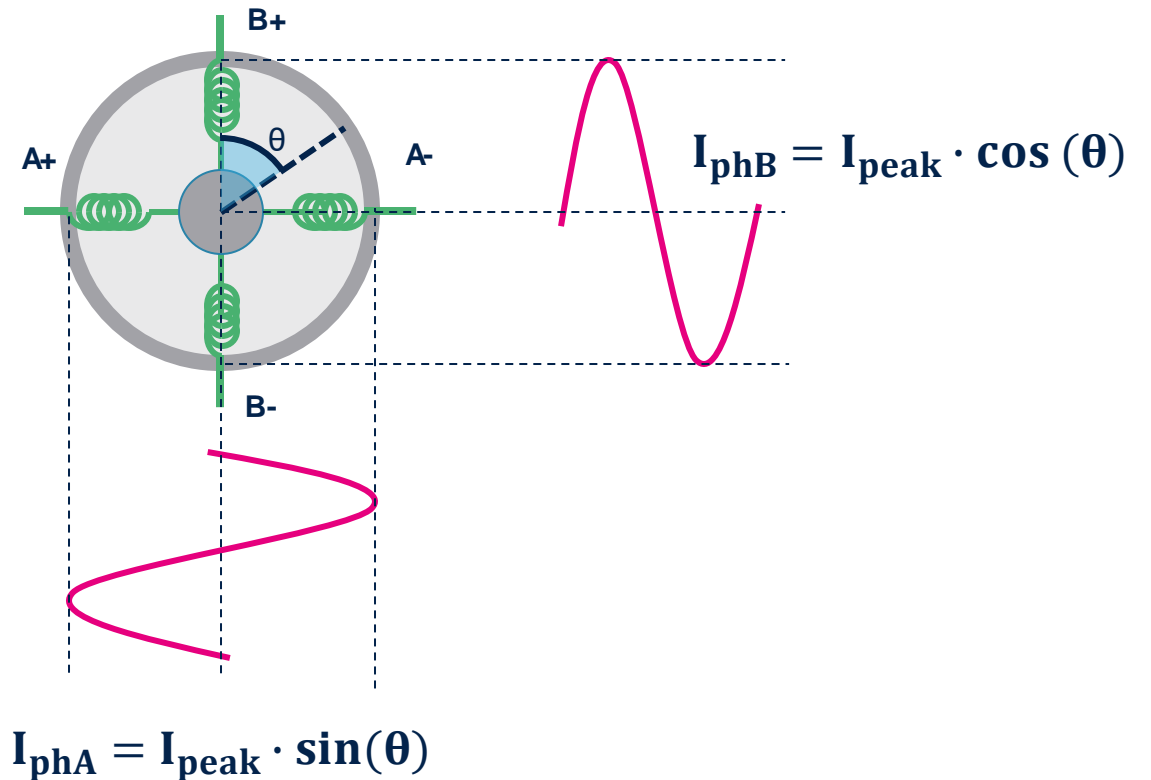



Bipolar stepper motor

Microstepping - Stall and step-loss

When the stepper motor is loaded with a torque exceeding its torque vs. speed characteristic a **stall** or a **step-loss** events could occur.

The stepper motor is in **stall** when it completely loses the synchronism. As result the rotor is stopped or vibrates, but no rotation is performed.

When a **step-loss** occurs the motor loses the synchronism for a short period and then resumes.

As result the rotor continues its rotation, but the actual position is different from the ideal one.



Bipolar stepper motor

Torque vs. Speed characteristic

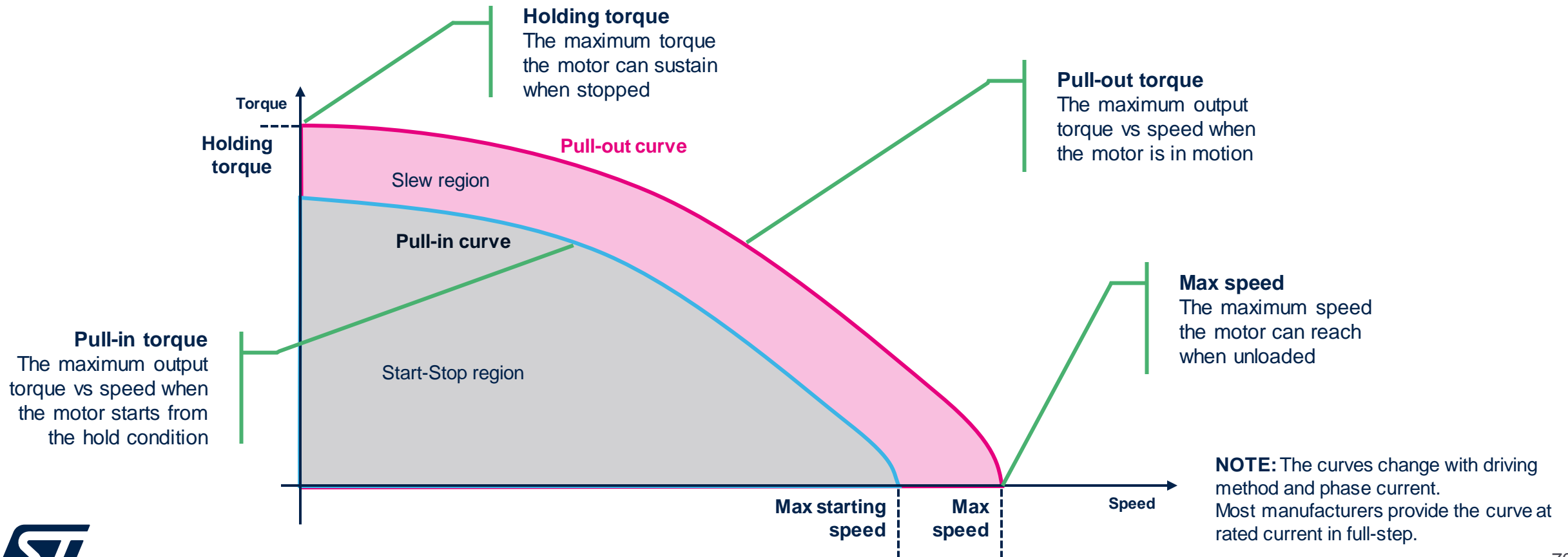

Resonances

Each time a step (or a microstep) is performed, the final position is not immediately asserted, but the rotor vibrates around the target position before stop.

When the step rate reaches the frequency of this vibration, the mechanic of the motor **resonates**.

This effect is named mid-point resonance.

The stepper motor should not operate in this condition.

Effects of the resonances:

- **Strong vibrations:** the motor is very noisy because the resonances stimulates the internal mechanic.
- **Reduced torque:** the energy is “dissipated” by the resonance (vibrations) so a minor part of the energy is converted into an effective torque.
- **Discontinuous motion:** if vibrations are strong enough to move the rotor in the unstable region step-loss events could occur.

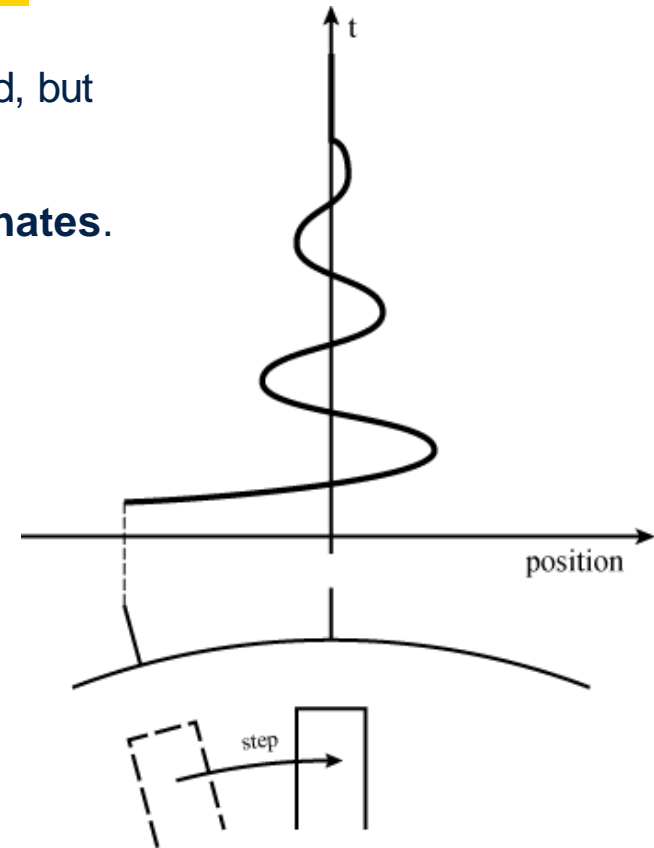



Bipolar stepper motor summary

- The stepper motor is designed to move the rotor in a target position and keep it.
- The stator magnetic field is the combination of the magnetic fields generated by the motor phases.
- Each combination of currents in the motor phases moves and keeps the motor in a stable position. At each position of the magnetic field more mechanical positions may correspond.
- The motor rotation is performed through a proper sequence of phase currents.
- The rotation is always performed one step (or microstep) at a time.



Thank you

More about motor control: <https://www.st.com/motor-control>

© STMicroelectronics - All rights reserved.

ST logo is a trademark or a registered trademark of STMicroelectronics International NV or its affiliates in the EU and/or other countries.

For additional information about ST trademarks, please refer to www.st.com/trademarks.

All other product or service names are the property of their respective owners.



life.augmented