Description of WLCSP for STMicroelectronics EEPROMs and recommendations for use

Introduction

This document describes the 5 and 8-bump WLCSPs (wafer level chip size package) used for STMicroelectronics EEPROM products, and provides recommendation on how to use them.

The competitive market of portable equipment, in particular the mobile phone market, is driven by the challenging development of highly integrated devices. To allow manufacturers of portable equipment to minimize the dimension of their devices, STMicroelectronics has developed WLCSP with reduced size, thickness and weight. The electrical performance of such components is improved by using shorter connections than in standard plastic packages such as TSSOP, SSOP or QFN.

The WLCSP family has been designed to fulfill the same quality levels and same reliability performance as standard semiconductor plastic packages. As a consequence these new WLCSP can be considered as new surface mount devices which are assembled on a printed circuit board (PCB) without any special or additional process steps. In particular these packages do not require any extra underfill to increase reliability performance or to protect the device. These packages are compatible with existing pick-and-place equipment for board mounting. Only Lead-free RoHS compliant WLCSP are available in mass production.

This document addresses the following topics:

- Package description
- Device marking
- Packing specifications and labelling
- Storage and shipping recommendations
- Soldering assembly recommendations
- Package changes
- Package quality

Contents

- 1 Package description 5**
 - 1.1 Overview 5
 - 1.2 Mechanical description 6
 - 1.3 Device marking 7
- 2 Packing specifications and labelling description 8**
 - 2.1 Carrier tape 8
 - 2.2 Cover tape 10
 - 2.3 Reels 10
 - 2.4 Final packing 12
 - 2.5 Labelling 12
 - 2.6 Storage and shipping recommendations 12
- 3 Soldering assembly recommendations 13**
 - 3.1 PCB design recommendations 13
 - 3.2 PCB assembly guidelines 13
 - 3.2.1 Protection against light exposure 14
- 4 Manual rework 15**
 - 4.1 Rework procedure 15
 - 4.2 Component rework equipment 16
- 5 Package changes 17**
- 6 Package quality 18**
 - 6.1 Electrical inspection 18
 - 6.2 Visual inspection 18
- 7 Conclusion 19**
- 8 Revision history 20**

List of tables

Table 1.	8-bump - 160 μ m ball WLCSP mechanical dimensions	6
Table 2.	Tape cavity size	10
Table 3.	7 inch reel dimensions	11
Table 4.	PCB design recommendation for 0.5 mm ball pitch packages	13
Table 5.	PCB design recommendation for 0.4 mm ball pitch packages	13
Table 6.	Document revision history	20

List of figures

Figure 1.	WLCSP bump views	5
Figure 2.	8-bump - 160µm ball WLCSP outline	6
Figure 3.	WLCSP device marking	7
Figure 4.	Typical tape dimensions for WLCSP packages in 8 mm carrier tape	8
Figure 5.	Typical tape dimensions for WLCSP packages in 12 mm carrier tape	9
Figure 6.	7 inch reel schematics	11
Figure 7.	Packing process	12
Figure 8.	JEDEC STD-020D soldering reflow profile	14
Figure 9.	Comintec ONYX32 semi-automatic equipment for component rework.	16

1 Package description

1.1 Overview

STMicroelectronics WLCSP are manufactured with a wafer level process by attaching solder balls on I/Os pads of the active wafer side, thus allowing bumped dice to be produced. The I/O contacts can be either configured as a matrix or located in the periphery. A redistribution layer is used.

Lead-free balls are manufactured using SAC (SnAgCu) alloy with a near-eutectic melting point ranging 217 to 221 °C. This material makes the package compatible with standard reflow processes.

The ball diameter allows to use pick-and-place process compatible with existing equipment, in particular with equipment used for ball grid array (BGA) packages. It also makes it compatible with the PCB design rules used for standard ICs.

The devices available in WLCSP are delivered in tape and reel packing with the bumps turned down (placed on the bottom of the carrier tape cavity). The other face of the device is flat and allows picking it as for standard SMD packages.

Caution: It is recommended to handle WLCSPs with care since they are built on a silicon substrate and are not protected against aggressive actions.

WLCSP Devices are 100 % electrically tested.

The device references are marked on the top flat side of the device (see [Figure 1](#)).

Figure 1. WLCSP bump views

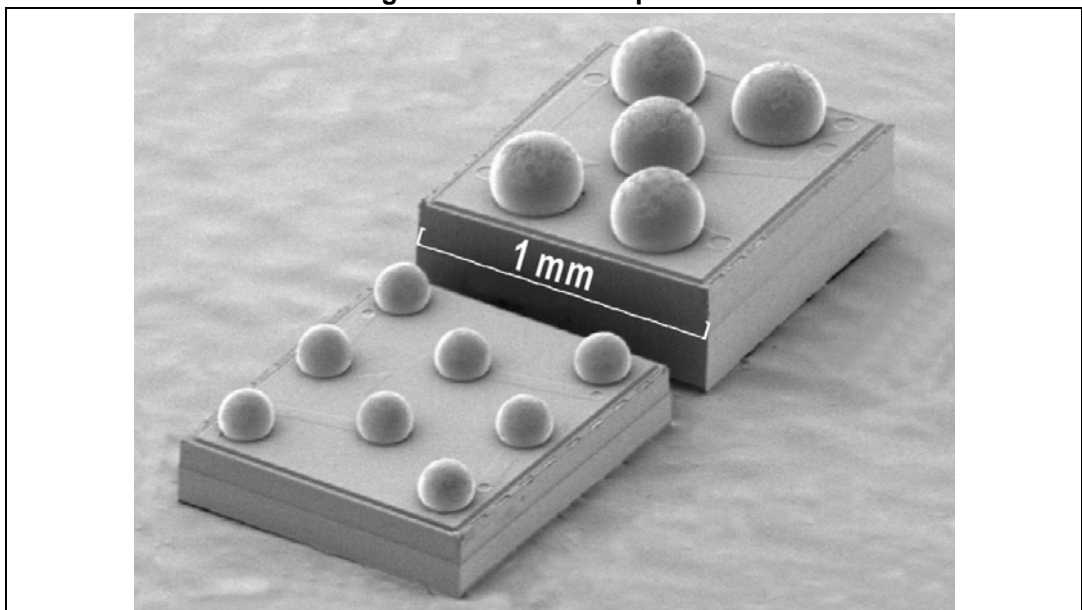

1.2 Mechanical description

An example of 8-bump WLCSP outline and mechanical dimensions is given in [Figure 2](#) and [Table 1](#). Die size and ball count are adapted to the connection requirements. Refer to device datasheet for package mechanical data and outline.

The WLCSP tolerances on ball diameter and ball height are very low. This constant ball shape insures a good coplanarity between balls. Optical measurements performed through vertical focuses show a ball-plus-die coplanarity well below 50 µm.

Figure 2. 8-bump - 160µm ball WLCSP outline

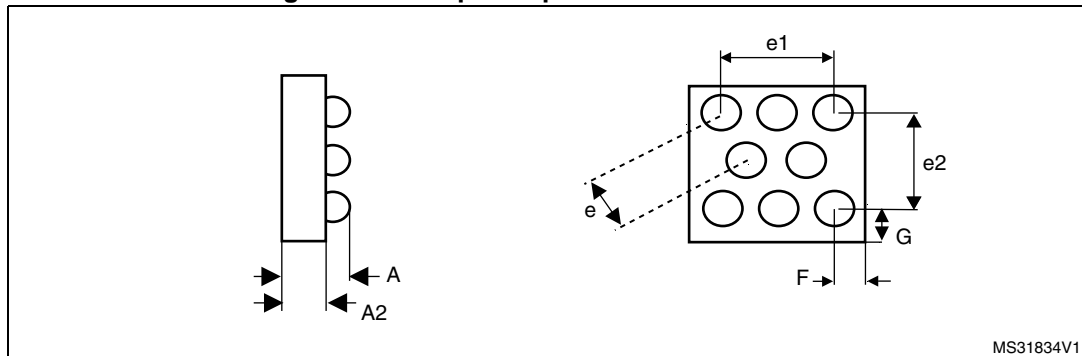

Table 1. 8-bump - 160µm ball WLCSP mechanical dimensions

Symbol	Typical (mm)
A	0.315
A2	0.200
F	0.137
G	0.133
e	0.400
e1	0.800
e2	0.693

Typical device marking for the flat backside of the die is shown on [Figure 3](#).

WLCSP ball 1 is identified by the A1 pin marked on the flat backside of the die so that the orientation of the component can be easily determined before and after assembly. This dot has been designed so that it can be detected by standard vision systems.

1.3 Device marking

The standard top-side laser marking contains:

- Pin 1 identification
- ST logo
- Marking areas composed of:
 - Commercial product name
 - Traceability code
 - Wafer fab code
 - Testing and finishing production location codes
 - Country where the product was assembled

Figure 3. WLCSP device marking

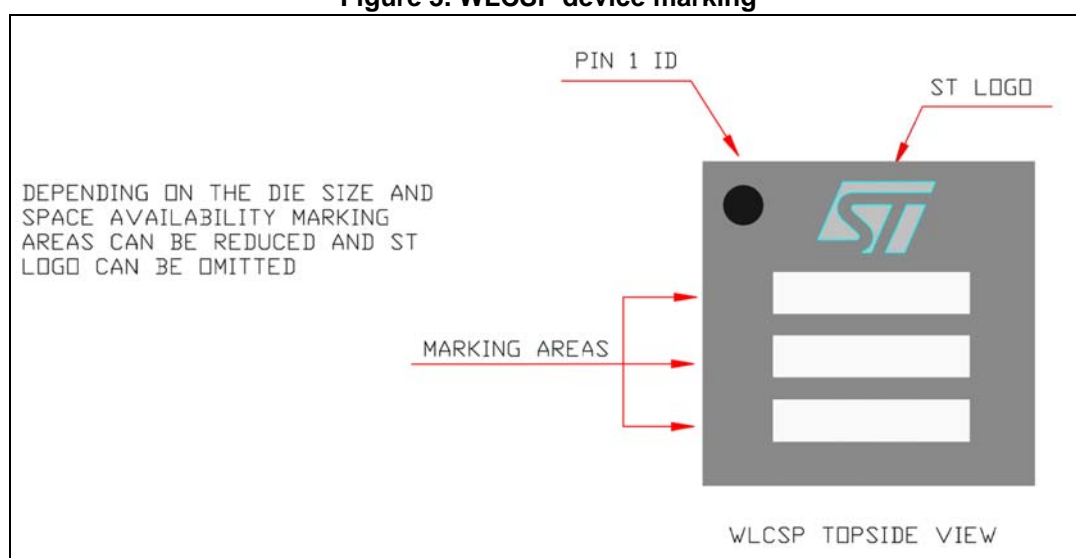

2 Packing specifications and labelling description

WLCSP devices are delivered in tape and reel to be fully compatible with standard high volume SMD components. All tape and reel characteristics are compliant with EIA-481-C and IEC 60286-3 standards and EIA 763 (783).

2.1 Carrier tape

The WLCSP are placed in carrier tapes with their ball side facing the bottom of the cavity so that the devices can be picked up by their flat side. No flipping of the package is required for mounting on the PCB. The devices are positioned in the carrier tape with pin A1 on the sprocket hole side.

Carrier tape mechanical dimensions are shown in *Figure 4* and *Figure 5*. The standard tape width is 8 mm for die size smaller than 3 mm (dimension B0). 12 mm carrier tape width may be used for larger die size to be in line with EIA standards.

Figure 4. Typical tape dimensions for WLCSP packages in 8 mm carrier tape

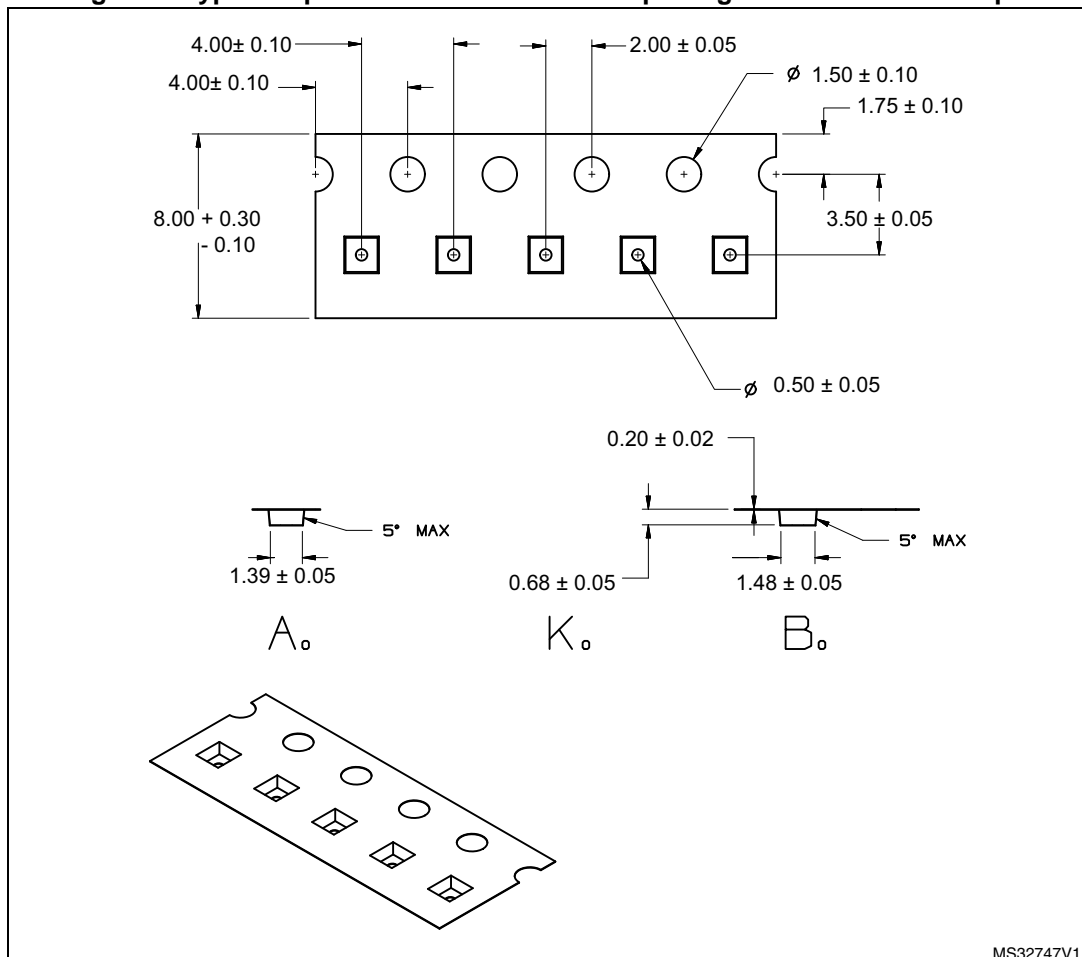

1. A1 bump location varies with the device layout.
2. The dimensions shown in the above figure are for illustrative purpose. Actual carrier tape dimensions may slightly differ.

Figure 5. Typical tape dimensions for WLCSP packages in 12 mm carrier tape

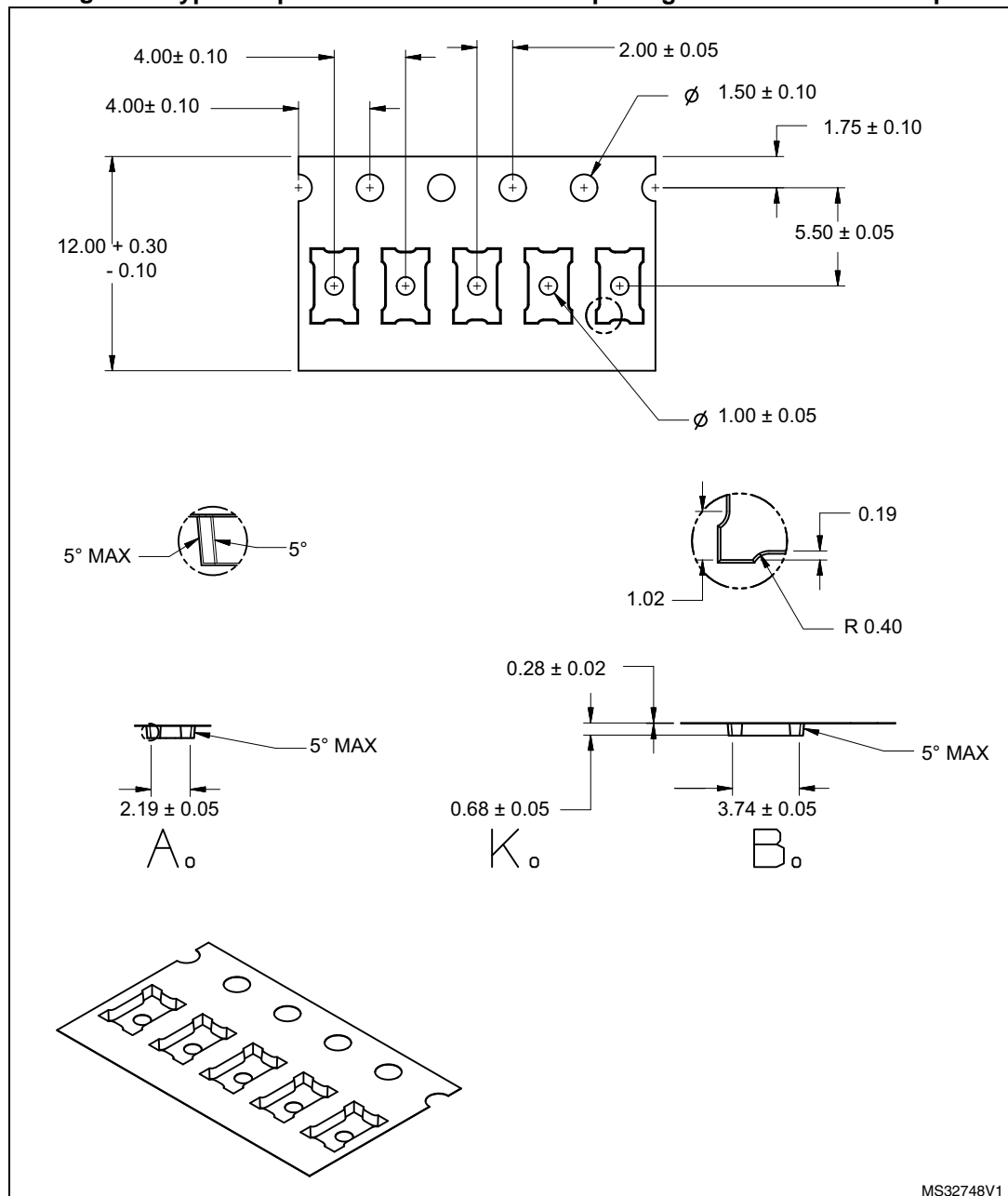

1. A1 bump location varies with the device layout.
2. The dimensions shown in the above figure are for illustrative purpose. Actual carrier tape dimensions may slightly differ.

The cavities in the carrier tape have been designed to avoid damaging the components. No hole is present in the cavity to avoid any impact or any external contamination of the solder bumps. Refer to [Table 2](#) for the cavity dimension according to the die size.

The embossed carrier tape is in a black conductive material (surface resistivity within 10^4 and $10^8 \Omega/\text{sq}$). Using this material prevents the component from being damaged by electrostatic discharge and ensures the total discharge of the component prior to the placement on the PCB. Conductivity is guaranteed to be constant and is not affected by

shelf life or humidity. The material does not break when bent and does not have any powder or flake residue that rubs off.

Table 2. Tape cavity size

Die dimensions	Tape cavity dimension (A0 and B0)
Die with both sides ≤ 1.5 mm	Die side size + 70 μm
Die with one side > 1.5 mm	Cavity dimensions must ensure that component rotation cannot exceed 5 ° max.

2.2 Cover tape

The carrier tape is sealed with a transparent antistatic (surface resistivity ranging from $10^5 \Omega/\text{sq}$ to $10^{12} \Omega/\text{sq}$) polyester film cover tape using a heat activated adhesive. The cover tape tensile strength is higher than 10 N.

The peeling force of the cover tape ranging from 0.1 N to 0.7 N in accordance with the testing method EIA-481-C and IEC 60286-3. Cover tape is peeled back in the direction opposite to the carrier tape travel. The angle between the cover tape and the carrier tape is between 165 and 180 °, and the test is performed at a speed of 120 ± 10 % mm/min.

2.3 Reels

The sealed carrier tape containing the WLCSP is reeled on 7 inch reels (see [Figure 6](#) and [Table 3](#) for reel mechanical dimensions). These reels are compliant with EIA-481-C standard. In particular, they are made of an antistatic polystyrene material. The reel color may vary depending on supplier.

Dice quantity per reel is 3000 (with typical package thickness equal to 650 μm). In compliance with the IEC 60286-3, each reel contains a maximum of 0.1 % empty cavities. Two successive empty cavities are not allowed. A reel may contain devices coming from 2 different wafer lots.

The reels have a minimum leader of 600 mm and a minimum trailer of 160 mm (in compliance with EIA-481-C and IEC 60286-3 standards). The leader makes up a portion of carrier tape with empty cavities and sealed by cover tape at the beginning of the reel (external side). It is affixed to the last turn of the carrier tape by using adhesive tape. The trailer is located at the end of the reel and consists of empty sealed cavities.

Figure 6. 7 inch reel schematics

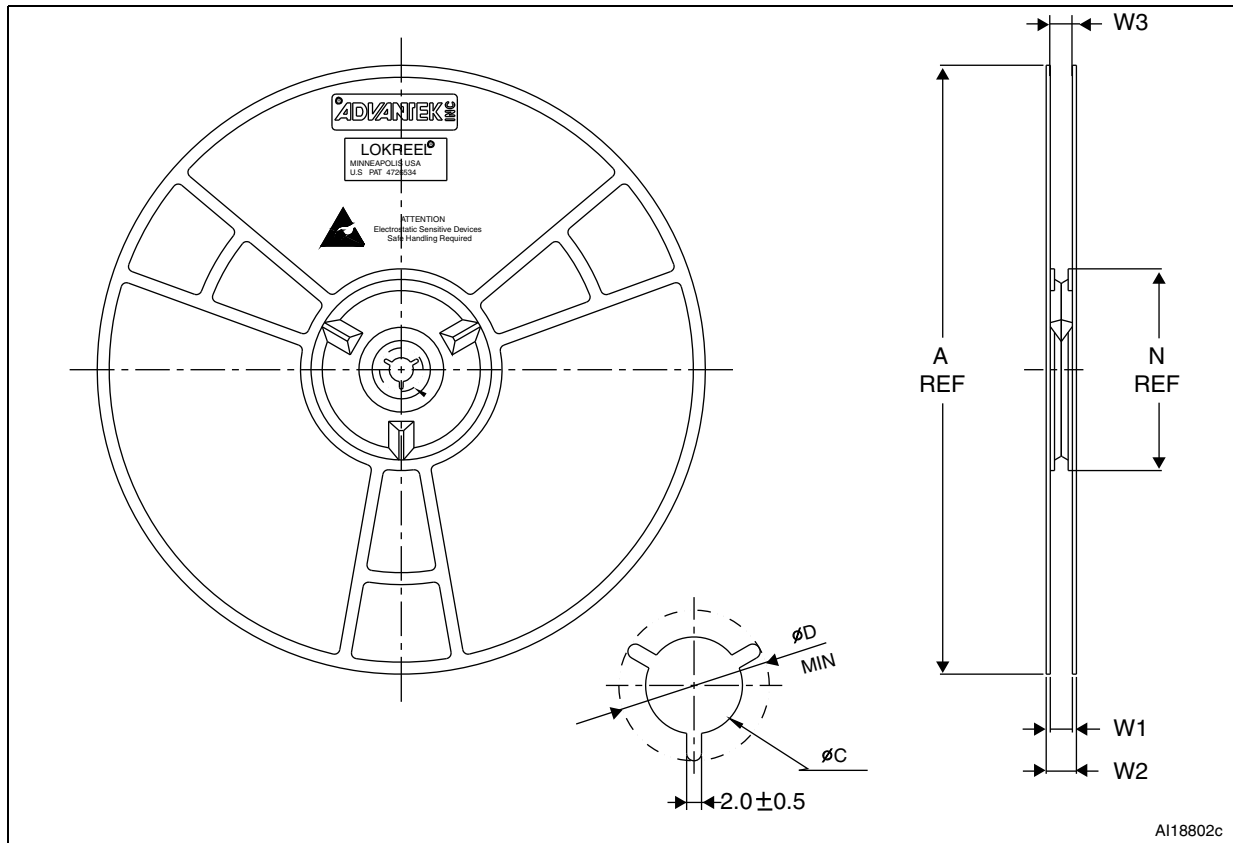

Table 3. 7 inch reel dimensions

Reel	W1 (mm) ⁽¹⁾⁽²⁾	W2 (mm) ⁽²⁾	W3 (mm)	A (mm)	C (mm)	D (mm)	N (mm)
7"	8.8 (typ)	14.2 (max)	8	177.8 (typ.)	13.0 ⁽³⁾	20.2 (min)	100.0 (typ)
	12.8 (typ)	18.2 (max)	12				
	16.8 (typ)	22.2 (max)	16				
	24.8 (typ)	30.2 (max)	24				
	32.8 (typ)	38.2 (max)	32				
	44.8 (typ)	50.2 (max)	44				

1. +0.6 mm, -0.4 mm.
2. Measured at the hub.
3. +0.5 mm, -0.2 mm.

2.4 Final packing

Each reel is heat-sealed under inert atmosphere in a transparent recyclable antistatic polyethylene bag (minimum of 4 mils material thickness). Reels are then packed in cardboard boxes. A full description of the packing process is shown in [Figure 7](#).

Figure 7. Packing process

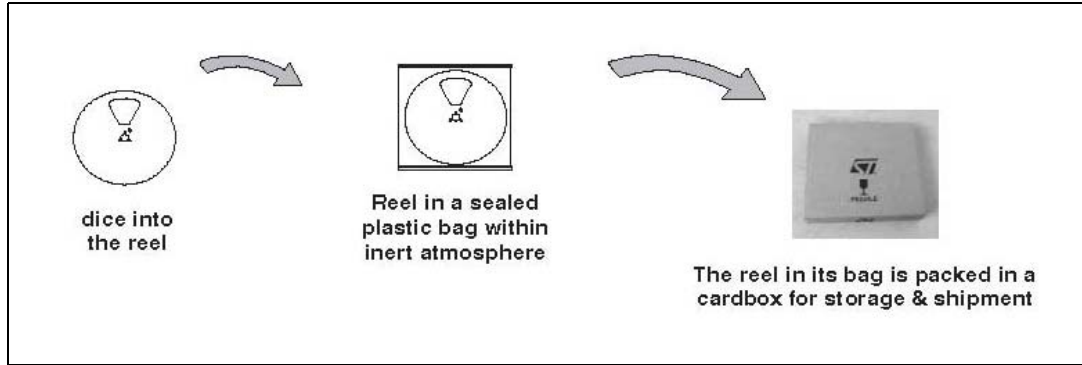

2.5 Labelling

To trace each production lot and shipment lot, the 7 inch reels and the cardboard box are identified by labels that mention the device part number, the shipped quantity and traceability information.

The trace code printed on the labels ensures backward traceability from the lot received by the customer to each step of the process. It includes in/ out dates, as well as quantities during diffusion, assembly, test phase, and in the final storage. Likewise, forward traceability is able to trace a lot history from the wafer fab to the customer location.

2.6 Storage and shipping recommendations

WLCSP reels are packed under inert N2 atmosphere in a sealed bag. For shipment and handling, reels are packed in a cardboard box.

ST consequently recommends the following shipping and storage conditions:

- Relative humidity between 15 and 70 %
- Temperature ranging from -55 to +150 °C.
- Components in a non opened sealed bag can be stored for 6 months after shipment.
- Components in tape and reel must be protected from exposure to direct sunlight.

Note: Moisture sensitivity level (MSL as per JEDEC J-STD-020) is not applicable to WLCSP devices since there is no plastic encapsulation.

3 Soldering assembly recommendations

3.1 PCB design recommendations

For optimum electrical performance and highly reliable solder joints, ST follows the PCB design guidelines listed in [Table 4](#) and [Table 5](#).

PCB pad positioning and size must properly designed to optimize the natural self-centering effect of the WLCSP on the PCB.

Note: A too thick gold layer finishing on the PCB pad is not recommended since it results in low joint reliability.

Table 4. PCB design recommendation for 0.5 mm ball pitch packages

PCB design list	Recommendation
PCB pad design	Non-solder mask defined micro via underbump allowed
PCB pad size	Ø = 300 µm max (circular) - 250 µm recommended
Solder mask opening	Ø = 340 µm min (for 300 µm diameter pad)
PCB pad finishing	Cu - Ni (2-6 µm) - Au (0.2 µm max)

Table 5. PCB design recommendation for 0.4 mm ball pitch packages

PCB design list	Recommendation
PCB pad design	Non-solder mask defined micro via underbump allowed
PCB pad size	Ø = 260 µm max (circular) - 220 µm recommended
Solder mask opening	Ø = 300 µm min (for 260 µm diameter pad)
PCB pad finishing	Cu - Ni (2-6 µm) - Au (0.2 µm max)

Micro vias

An alternative to routing on the top surface is to route out on buried layers. To achieve this, the pads must be connected to the lower layers using micro vias.

3.2 PCB assembly guidelines

To mount a WLCSP on a PCB, ST recommends the use of a solder stencil with an aperture of 330 x 330 µm² maximum and a stencil typical thickness of 125 µm. WLCSP are fully compatible with the use of near-eutectic SAC solder paste with no-clean flux.

ST has qualified WLCSP packages using JEDEC STD-020D soldering reflow profile shown in [Figure 8](#):

- Dwell time in the soldering zone (with temperature higher than 220 °C) has been kept as short as possible to prevent component and substrate damages.
- Peak temperature must not exceed 260 °C.
- Controlled atmosphere (N₂ or N₂H₂) is recommended during the whole reflow, especially when the temperature is above 150 °C.

WLCSP can withstand three times the previous recommended reflow profile to be compatible with a double reflow when SMDs are mounted on both sides of the PCB plus one additional repair.

A maximum of three soldering reflows are allowed for these Lead-free packages (with repair step included).

The use of a no-clean flux is highly recommended to avoid any cleaning operation. To prevent any bump cracks, ultrasonic cleaning methods are not recommended.

Figure 8. JEDEC STD-020D soldering reflow profile

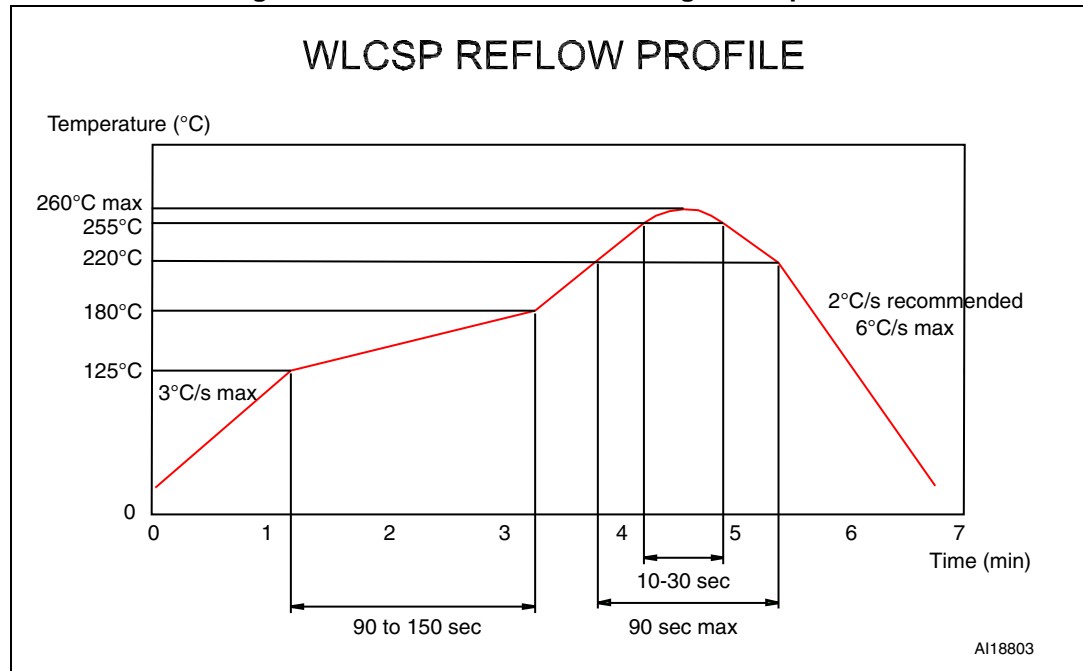

3.2.1 Protection against light exposure

WLCSP, when placed in a non-opaque housing for specific customer application, may be exposed to various light sources such as incandescent light or sun light.

Since WLCSPs are light sensitive, it is recommended to protect them with an opaque layer to prevent light from entering the semiconductor substrate through the top side or through the lateral edges of the device.

4 Manual rework

WLCSP can tolerate one repair in addition to the two reflows mentioned above.

Like other BGA packages, the use of laser systems is the most suitable solution to repair WLCSP. Manual hot gas soldering is acceptable while iron soldering is not recommended.

The maximum temperature allowed for Lead-free WLCSP manual rework is 260 °C. The typical soldering profile shown [Figure 8](#) can be used.

4.1 Rework procedure

To perform manual rework on a WLCSP, it is recommended to follow the steps below:

1. Remove the device

To remove the device, heat must be applied to melt the solder joints so that the component can be lifted from the board.

Large area bottom side preheaters may be used to raise the temperature of the board. This may help to minimize board warpage and the amount of heat that must be applied on the component.

Top heating may be applied to the component by using a laser or a convective hot gas nozzle. Nozzle size must be selected to match the component footprint. After top heating has melted the solder, vacuum is applied through the pick-up nozzle, and the component is lifted from the board.

The heat should be carefully directed at the component which must be removed to prevent adjacent components solder joints from being reflowed. Shielding, control of the gas flow from the nozzle, and accurate temperature control are the key parameters.

2. Remove the solder

Automatic tools are recommended due to space constraints and the need for accurate temperature control,

Typical cleaners are controlled non-contact gas heating and vacuuming tools. The objective is to remove the residual solder from the area without damaging the pads, solder masks or adjacent components, and to prepare the area for the insertion of the new component.

3. New device soldering

a) Place the new device

There are several solutions to place the new device:

- Use a mini-stencil and solder paste, then place the device. This is the solution recommended to ensure homogeneity of assembly conditions if solder paste is used, even if small footprints and tight dimensions make this operation difficult.
- Use no-clean flux on the area and place the device over the flux on the board.
- Dip the WLCSP in no-clean flux, and place it on the board.

b) Reflow the solder joint by applying controlled heat to the component.

The steps are similar to those required to remove a component. However, accurate temperature control is recommended to ensure good joint soldering.

A alternative solution is to put the whole board in a furnace. See [Figure 8](#) for reflow profile recommendations.

4.2 Component rework equipment

The systems required to perform rework are available at various levels of automation. The methods and techniques used in more sophisticated automatic systems can be copied for manual equipment. Soldering irons must be avoided for these operations. Tweezers or picking tools must be avoided since they can damage devices and create die chip-outs by compressing the WLCSP top or bottom sides (ball side).

Figure 8. shows an example of semi-automatic equipment for component rework. For more information, refer to Comintec web site at <http://www.comintec.it>.

Figure 9. Comintec ONYX32 semi-automatic equipment for component rework



5 Package changes

STMicroelectronics reserves the right to implement minor changes of geometry and manufacturing processes without prior notice. Such changes will not affect electrical characteristics of the die, the pad layout or the maximum die size. However for confirmed orders, no variation will be made without prior customer's approval.

6 Package quality

6.1 Electrical inspection

All the critical parameters defined in the WLCSP device datasheet are 100 % electrically characterized. The other parameters are guaranteed by technology, design rules or by continuous monitoring systems.

6.2 Visual inspection

A visual control is performed on all manufacturing lots according to JESD22_B101B specification.

7 Conclusion

Lead-free WLCSP have been developed by STMicroelectronics for electronic applications where integration and performance are designer's main concerns.

STMicroelectronics WLCSP key features are:

- Remarkable board space saving: package size equal to die size and total height less than 650 μm
- Enhanced electrical performance: minimized parasitic inductance due to very short electrical paths.

WLCSP are delivered in tape and reel and are fully compatible with other high volume SMD components (standard plastic packages or CSP/BGA packages) in regards to existing pick-and-place equipment, standard solder reflow assembly equipment and standard PCB techniques.

8 Revision history

Table 6. Document revision history

Date	Revision	Changes
03-Apr-2013	1	Initial release.
23-Jul-2013	2	Replaced <i>Figure 4: Typical tape dimensions for WLCSP packages</i> by <i>Figure 4: Typical tape dimensions for WLCSP packages in 8 mm carrier tape</i> and <i>Figure 5: Typical tape dimensions for WLCSP packages in 12 mm carrier tape.</i> Updated <i>Table 3: 7 inch reel dimensions.</i>

Please Read Carefully:

Information in this document is provided solely in connection with ST products. STMicroelectronics NV and its subsidiaries ("ST") reserve the right to make changes, corrections, modifications or improvements, to this document, and the products and services described herein at any time, without notice.

All ST products are sold pursuant to ST's terms and conditions of sale.

Purchasers are solely responsible for the choice, selection and use of the ST products and services described herein, and ST assumes no liability whatsoever relating to the choice, selection or use of the ST products and services described herein.

No license, express or implied, by estoppel or otherwise, to any intellectual property rights is granted under this document. If any part of this document refers to any third party products or services it shall not be deemed a license grant by ST for the use of such third party products or services, or any intellectual property contained therein or considered as a warranty covering the use in any manner whatsoever of such third party products or services or any intellectual property contained therein.

UNLESS OTHERWISE SET FORTH IN ST'S TERMS AND CONDITIONS OF SALE ST DISCLAIMS ANY EXPRESS OR IMPLIED WARRANTY WITH RESPECT TO THE USE AND/OR SALE OF ST PRODUCTS INCLUDING WITHOUT LIMITATION IMPLIED WARRANTIES OF MERCHANTABILITY, FITNESS FOR A PARTICULAR PURPOSE (AND THEIR EQUIVALENTS UNDER THE LAWS OF ANY JURISDICTION), OR INFRINGEMENT OF ANY PATENT, COPYRIGHT OR OTHER INTELLECTUAL PROPERTY RIGHT.

ST PRODUCTS ARE NOT AUTHORIZED FOR USE IN WEAPONS. NOR ARE ST PRODUCTS DESIGNED OR AUTHORIZED FOR USE IN: (A) SAFETY CRITICAL APPLICATIONS SUCH AS LIFE SUPPORTING, ACTIVE IMPLANTED DEVICES OR SYSTEMS WITH PRODUCT FUNCTIONAL SAFETY REQUIREMENTS; (B) AERONAUTIC APPLICATIONS; (C) AUTOMOTIVE APPLICATIONS OR ENVIRONMENTS, AND/OR (D) AEROSPACE APPLICATIONS OR ENVIRONMENTS. WHERE ST PRODUCTS ARE NOT DESIGNED FOR SUCH USE, THE PURCHASER SHALL USE PRODUCTS AT PURCHASER'S SOLE RISK, EVEN IF ST HAS BEEN INFORMED IN WRITING OF SUCH USAGE, UNLESS A PRODUCT IS EXPRESSLY DESIGNATED BY ST AS BEING INTENDED FOR "AUTOMOTIVE, AUTOMOTIVE SAFETY OR MEDICAL" INDUSTRY DOMAINS ACCORDING TO ST PRODUCT DESIGN SPECIFICATIONS. PRODUCTS FORMALLY ESCC, QML OR JAN QUALIFIED ARE DEEMED SUITABLE FOR USE IN AEROSPACE BY THE CORRESPONDING GOVERNMENTAL AGENCY.

Resale of ST products with provisions different from the statements and/or technical features set forth in this document shall immediately void any warranty granted by ST for the ST product or service described herein and shall not create or extend in any manner whatsoever, any liability of ST.

ST and the ST logo are trademarks or registered trademarks of ST in various countries.

Information in this document supersedes and replaces all information previously supplied.

The ST logo is a registered trademark of STMicroelectronics. All other names are the property of their respective owners.

© 2013 STMicroelectronics - All rights reserved

STMicroelectronics group of companies

Australia - Belgium - Brazil - Canada - China - Czech Republic - Finland - France - Germany - Hong Kong - India - Israel - Italy - Japan - Malaysia - Malta - Morocco - Philippines - Singapore - Spain - Sweden - Switzerland - United Kingdom - United States of America

www.st.com

