



## **1 Overview**

This document concern the main features of PTB801DC valve drivers for ABS board with 2 x L9349 devices.

### **1.1 Introduction**

The PTB801DC is a complete demonstrator of an ABS system based on STMicroelectronics devices. The board implements a flexible and open design demonstrating the capability of the STMicroelectronics 16/32 bit microcontrollers and devices for ABS applications. The PTB801DC mounts two L9349 devices and accept external signal coming from PTB801 MB.

### **1.2 Main components**

- L9349 valve drivers
- Connector for valves with supply
- Connector for I/O, enables signals
- Standardized CPU board connector (PTB801 MB) providing access to off board I/O, PWM, SPI and power supply

---

# Contents

- 1 Overview ..... 1**
  - 1.1 Introduction ..... 1
  - 1.2 Main components ..... 1
  
- 2 Evaluation board description ..... 5**
  - 2.1 Features ..... 5
    - 2.1.1 L9349 quad intelligent power low-side switch ..... 5
  - 2.2 Board connections ..... 7
  
- 3 Before you start ..... 10**
  - 3.1 How to exercise diagnostic functionality ..... 10
  
- 4 Hardware ..... 11**
  - 4.1 PTB801DC overview ..... 11
  
- 5 Revision history ..... 12**

## List of tables

Table 1.	Valve connectors J5 and J6 .....	7
Table 2.	Valve connectors J4, J8 and J10 .....	8
Table 3.	Valve connectors J7, J9 and J11 .....	9
Table 4.	Valve connectors J3 .....	9
Table 5.	Document revision history .....	12

## List of figures

Figure 1.	L9349 pin connection (top view) . . . . .	5
Figure 2.	L9349 block diagram . . . . .	6
Figure 3.	Valves controlled by first L9349 . . . . .	7
Figure 4.	Valves controlled by second L9349 . . . . .	7
Figure 5.	First L9349 signals monitoring connectors . . . . .	8
Figure 6.	Second L9349 signals monitoring connectors . . . . .	8
Figure 7.	Enabled status connectors . . . . .	9
Figure 8.	Layout 2 x L9349 . . . . .	11

## 2 Evaluation board description

The PTB801DC is a valve drivers board for ABS system based on STMicroelectronics devices. The board implements a flexible and open design demonstrating the capability of the STMicroelectronics for ABS applications. The PTB801DC mounts two L9349 devices, the control coming from UN24 mother board.

The board has opened connectivity to external valves.

### 2.1 Features

General features of this board are:

- Full evaluation and development system based on the system basis chip L9349
- Full system evaluation: integration, basic and safety functions

#### 2.1.1 L9349 quad intelligent power low-side switch

The L9349 is a monolithic integrated quad low side driver realized in an advanced BCDmultipower mixed technology. The device is intended to drive valves in automotive environment.

**Figure 1. L9349 pin connection (top view)**

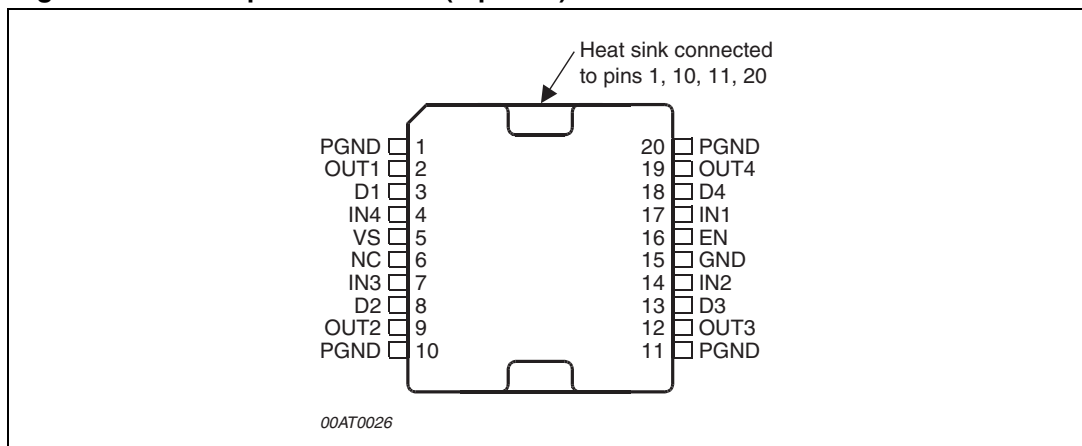

The L9349 is a quad low-side driver with following functions:

- Quad power low side driver with 2 x 5 A and 2 x 3 A output current capability
- Low  $R_{\text{DS(on)}}$  typically 200 m $\Omega$  and 300 m $\Omega$  @  $T_j = 25^\circ\text{C}$
- Internal output clamping structures with  $V_{\text{FB}} = 50\text{V}$  for fast inductive load current recirculation
- Limited output voltage slew rate for low EMI
- Protected  $\mu\text{P}$  compatible enable and input
- Wide operating supply voltage range 4.5 V to 32 V

- Real time diagnostic functions:
  - Output shorted to GND
  - Output shorted to Vss
  - Open load detection in ON and OFF condition
  - Load bypass detection
  - Overtemperature detection
- Device protection functions:
  - Overload disable
  - Selective thermal shutdown
- Signal- and power-ground-loss shutdown

Figure 2. L9349 block diagram

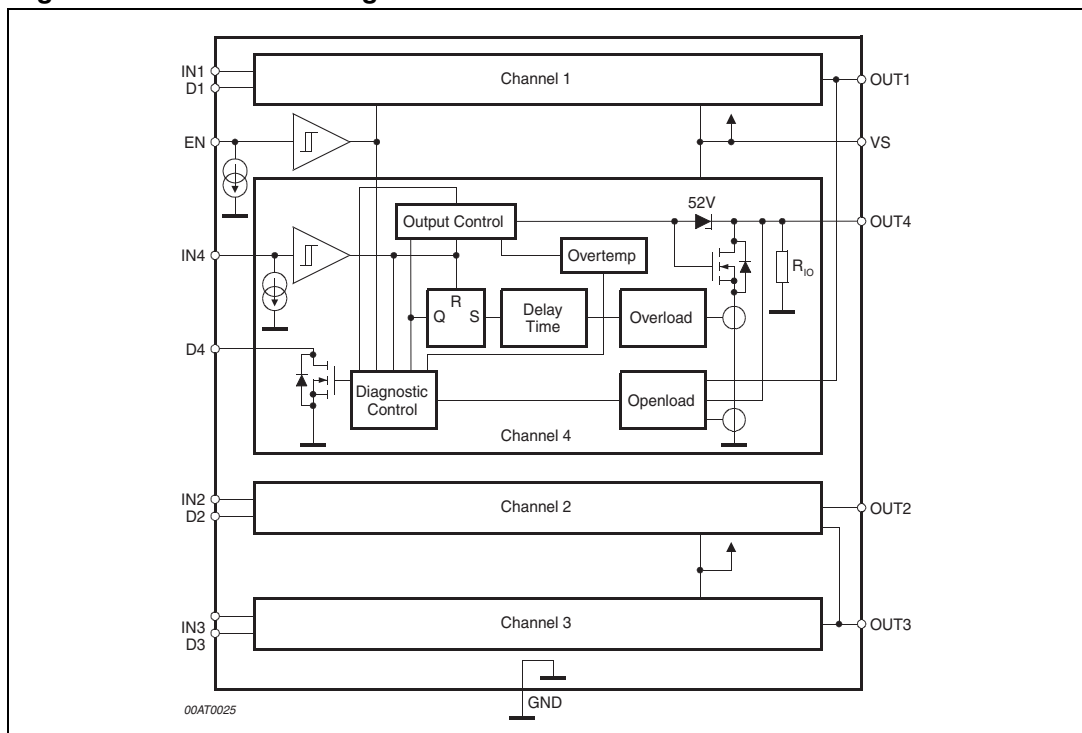

## 2.2 Board connections

PTB801DC has many connector to communicate with:

- UN24 mother board
- External valves

**Figure 3. Valves controlled by first L9349**

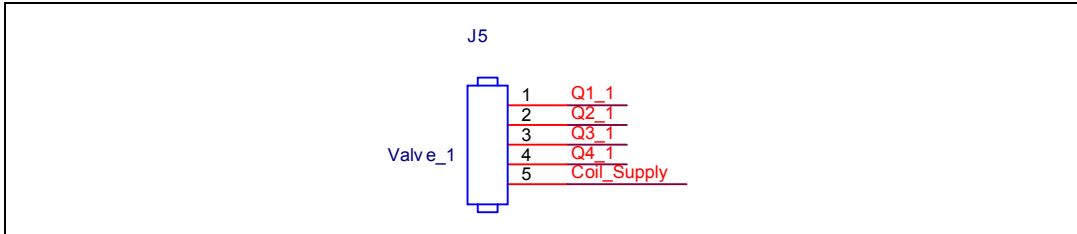

**Figure 4. Valves controlled by second L9349**

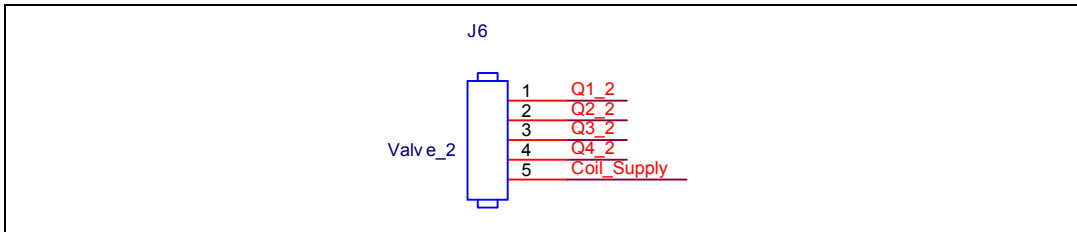

The following table describes the pin out of the valve connectors J5 and J6:

**Table 1. Valve connectors J5 and J6**

Name	Figure	Description
J5 Pin 1	<i>Figure 3.</i>	Output Q1 of first driver
J5 Pin 2		Output Q2 of first driver
J5 Pin 3		Output Q3 of first driver
J5 Pin 4		Output Q4 of first driver
J5 Pin 5		Coil Supply
J6 Pin 1	<i>Figure 4.</i>	Output Q1 of second driver
J6 Pin 2		Output Q2 of second driver
J6 Pin 3		Output Q3 of second driver
J6 Pin 4		Output Q4 of second driver
J6 Pin 5		Coil Supply

On the board, there are three connectors to monitoring the input (INx\_1), output (Qx\_1), and status (STx\_1) of the drivers.

**Figure 5. First L9349 signals monitoring connectors**

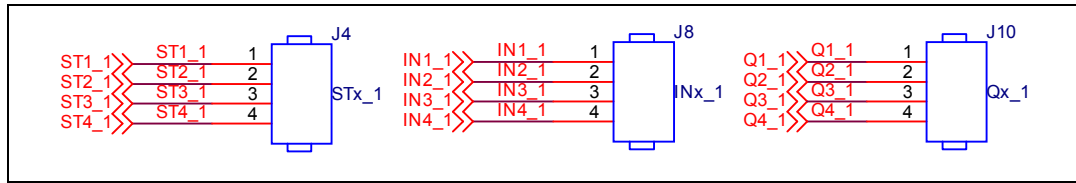

The following table describes the pin out of the first signals monitoring connectors J4, J8 and J10:

**Table 2. Valve connectors J4, J8 and J10**

Name	Figure	Description
J4 Pin 1	<i>Figure 5.</i>	Status Q1 of first driver
J4 Pin 2		Status Q2 of first driver
J4 Pin 3		Status Q3 of first driver
J4 Pin 4		Status Q4 of first driver
J8 Pin 1		Input Q1 of first driver
J8 Pin 2		Input Q2 of first driver
J8 Pin 3		Input Q3 of first driver
J8 Pin 4		Input Q4 of first driver
J10 Pin 1		Output Q1 of first driver
J10 Pin 2		Output Q2 of first driver
J10 Pin 3		Output Q3 of first driver
J10 Pin 4		Output Q4 of first driver

On the board, there are three connectors to monitoring the input (INx\_2), output (Qx\_2), and status (STx\_2) of the drivers.

**Figure 6. Second L9349 signals monitoring connectors**

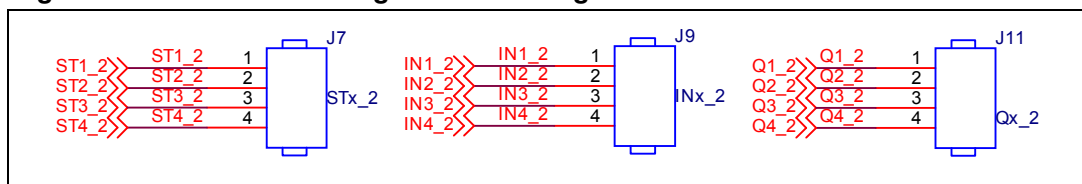

The following table describes the pin out of the second signals monitoring connectors J7, J9 and J11:

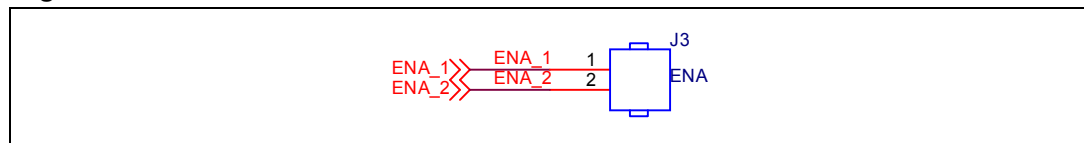

**Table 3. Valve connectors J7, J9 and J11**

Name	Figure	Description
J7 Pin 1	<i>Figure 6.</i>	Status Q1 of second driver
J7 Pin 2		Status Q2 of second driver
J7 Pin 3		Status Q3 of second driver
J7 Pin 4		Status Q4 of second driver
J9 Pin 1		Input Q1 of second driver
J9 Pin 2		Input Q2 of second driver
J9 Pin 3		Input Q3 of second driver
J9 Pin 4		Input Q4 of second driver
J11 Pin 1		Output Q1 of second driver
J11 Pin 2		Output Q2 of second driver
J11 Pin 3		Output Q3 of second driver
J11 Pin 4		Output Q4 of second driver

On the board there are a connector to monitoring the enabled status of the L9349 drivers.

**Figure 7. Enabled status connectors**



The following table describes the pin out of the enable L9349 drivers:

**Table 4. Valve connectors J3**

Name	Figure	Description
J3 Pin 1	<i>Figure 7.</i>	Enable first L9349 valve driver
J3 Pin 2		Enable second L9349 valve driver

## 3 Before you start

This section describes operations needed before powering up the board.

Before powering up the mother board, could connect:

- Daughter board 2 x L9349
- Wheel Speed Sensor board
- $\mu$ C mini module (ST10/SPC family)

### 3.1 How to exercise diagnostic functionality

The PTB801DC has many diagnostic features. Please see the L9349 datasheet for detail.

# 4 Hardware

This chapter describes all the hardware modules of the board.

## 4.1 PTB801DC overview

The PTB801DC is a specific platform for ABS valve drivers system with parallel interface.

Figure 8. Layout 2 x L9349

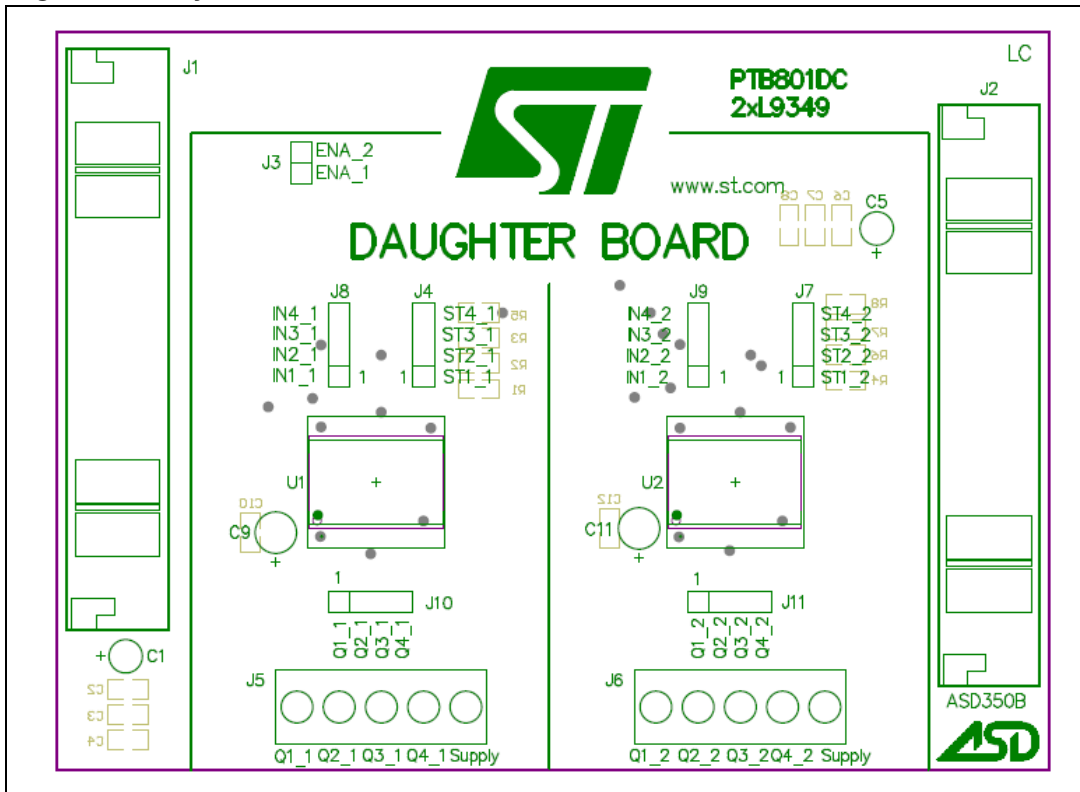

## 5 Revision history

**Table 5. Document revision history**

Date	Revision	Changes
28-May-2009	1	Initial release.
17-Sep-2013	2	Updated Disclaimer.

**Please Read Carefully:**

Information in this document is provided solely in connection with ST products. STMicroelectronics NV and its subsidiaries ("ST") reserve the right to make changes, corrections, modifications or improvements, to this document, and the products and services described herein at any time, without notice.

All ST products are sold pursuant to ST's terms and conditions of sale.

Purchasers are solely responsible for the choice, selection and use of the ST products and services described herein, and ST assumes no liability whatsoever relating to the choice, selection or use of the ST products and services described herein.

No license, express or implied, by estoppel or otherwise, to any intellectual property rights is granted under this document. If any part of this document refers to any third party products or services it shall not be deemed a license grant by ST for the use of such third party products or services, or any intellectual property contained therein or considered as a warranty covering the use in any manner whatsoever of such third party products or services or any intellectual property contained therein.

**UNLESS OTHERWISE SET FORTH IN ST'S TERMS AND CONDITIONS OF SALE ST DISCLAIMS ANY EXPRESS OR IMPLIED WARRANTY WITH RESPECT TO THE USE AND/OR SALE OF ST PRODUCTS INCLUDING WITHOUT LIMITATION IMPLIED WARRANTIES OF MERCHANTABILITY, FITNESS FOR A PARTICULAR PURPOSE (AND THEIR EQUIVALENTS UNDER THE LAWS OF ANY JURISDICTION), OR INFRINGEMENT OF ANY PATENT, COPYRIGHT OR OTHER INTELLECTUAL PROPERTY RIGHT.**

**ST PRODUCTS ARE NOT DESIGNED OR AUTHORIZED FOR USE IN: (A) SAFETY CRITICAL APPLICATIONS SUCH AS LIFE SUPPORTING, ACTIVE IMPLANTED DEVICES OR SYSTEMS WITH PRODUCT FUNCTIONAL SAFETY REQUIREMENTS; (B) AERONAUTIC APPLICATIONS; (C) AUTOMOTIVE APPLICATIONS OR ENVIRONMENTS, AND/OR (D) AEROSPACE APPLICATIONS OR ENVIRONMENTS. WHERE ST PRODUCTS ARE NOT DESIGNED FOR SUCH USE, THE PURCHASER SHALL USE PRODUCTS AT PURCHASER'S SOLE RISK, EVEN IF ST HAS BEEN INFORMED IN WRITING OF SUCH USAGE, UNLESS A PRODUCT IS EXPRESSLY DESIGNATED BY ST AS BEING INTENDED FOR "AUTOMOTIVE, AUTOMOTIVE SAFETY OR MEDICAL" INDUSTRY DOMAINS ACCORDING TO ST PRODUCT DESIGN SPECIFICATIONS. PRODUCTS FORMALLY ESCC, QML OR JAN QUALIFIED ARE DEEMED SUITABLE FOR USE IN AEROSPACE BY THE CORRESPONDING GOVERNMENTAL AGENCY.**

Resale of ST products with provisions different from the statements and/or technical features set forth in this document shall immediately void any warranty granted by ST for the ST product or service described herein and shall not create or extend in any manner whatsoever, any liability of ST.

ST and the ST logo are trademarks or registered trademarks of ST in various countries.

Information in this document supersedes and replaces all information previously supplied.

The ST logo is a registered trademark of STMicroelectronics. All other names are the property of their respective owners.

© 2013 STMicroelectronics - All rights reserved

STMicroelectronics group of companies

Australia - Belgium - Brazil - Canada - China - Czech Republic - Finland - France - Germany - Hong Kong - India - Israel - Italy - Japan - Malaysia - Malta - Morocco - Philippines - Singapore - Spain - Sweden - Switzerland - United Kingdom - United States of America

[www.st.com](http://www.st.com)