Fast and easy migration from DC barrel to Type-C

Introduction

The STREF-SCS001V1 reference design lets you create a USB Type-C connector quickly and easily in order to power any application up to 100 W (20 V, 5 A).

The status LED indicates the operating status of the STUSB4500 and USB PD port.

The USB PD port is pre-configured with the following default voltage values:

- PDO1: 5 V / 1.5A
- PDO2: 15 V / 1.5A
- PDO3: 20 V / 1.0A

Figure 1. STREF-SCS001V1 board photo



1 Functional diagram

Figure 2. STREF-SCS001V1 functional diagram

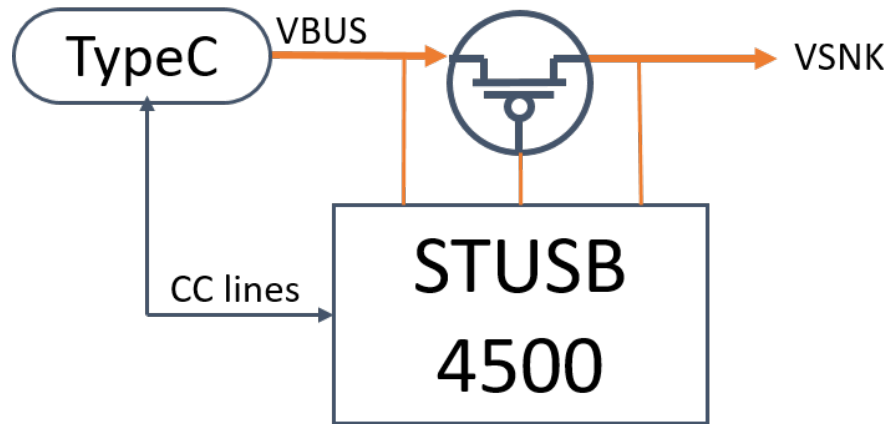

2 Getting started

The Type-C port is managed by the STUSB4500 in fully autonomous mode. When a connection is detected, the load device (VSNK) is connected to VBUS power by the PMOS controlled by the STUSB4500 device.

When attached to a Type-C / Power Delivery source, the STUSB4500 negotiates voltage according to the following priority list:

- 20 V / 1.0 A (PDO3 : preferred)
- 15 V / 1.5 A (PDO2)
- 5 V / 1.5 A (PDO1 : default)

A status LED indicates the voltage present on the VSNK:

- Light blue = 5 V
- Pink = PDO2 / 15 V
- Bright blue = 20 V

3 Schematic diagram

Figure 3. STREF-SCS001V1 schematic

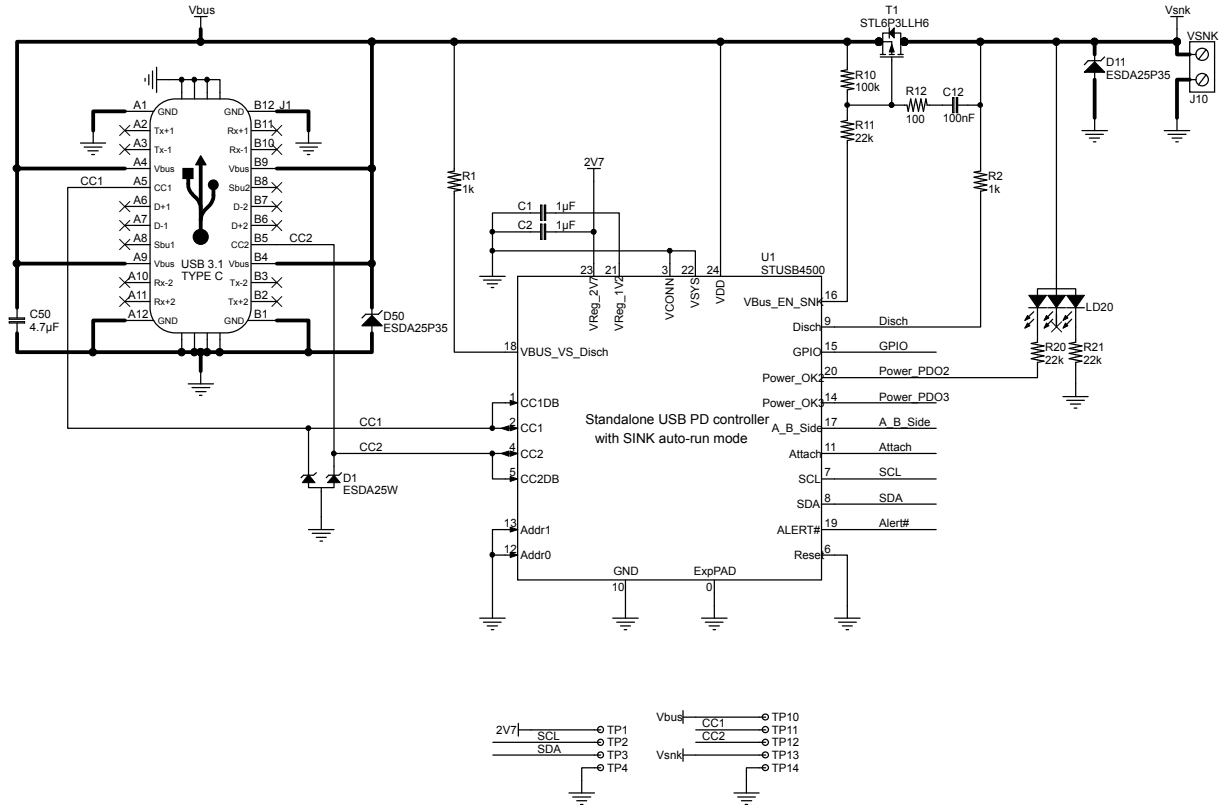

4 Bill of material

Item	Q.ty	Ref.	Value	Package	Manufacturer	Order code
1	2	C1, C2	1 μ F	Capacitor 1 μ F X5R 6V3 20% 0402	Würth Elektronik	885012105006
2	1	C12	100nF	Capacitor 100nF X5R 25V 20% 0402	Würth Elektronik	885012105018
3	1	C50	4.7 μ F	Capacitor 4.7 μ F X7R 25V 20% 0805	Würth Elektronik	885012107018
4	1	D1	25V TRANSIL SOT323	Dual Transil Array For ESD Protection in SOT323 Vbr = 25V	ST	ESDA25W
5	2	D11, D50	22V	High power transient voltage suppressor Vbr = 24.6	ST	ESDA25P35-1U1M
6	1	J1		USB 3.1 Type C Receptacle Horizontal THR WR-COM 1.6mm PCB thickness	Würth Elektronik	632723300011
7	1	J10		2 way PCB vertical mount SCREW terminal, 2.54mm	Würth Elektronik	691210910002
8	1	LD20		RGB Led 1.6 x 1.6 mm Diffused	Würth Elektronik	150066M153000
9	2	R1, R2	1k \pm 5%	0603 SMD resistor		
10	1	R10	100k \pm 5%	0402 SMD resistor		
11	3	R11, R20, R21	22k \pm 5%	0402 SMD resistor		
12	1	R12	100 \pm 5%	0402 SMD resistor		
13	1	T1	STL6P3LLH6	P-channel 30 V, 0.024 Ω typ., 6 A STripFET H6 Power MOSFET in a PowerFLAT 3.3 x 3.3 package	ST	STL6P3LLH6
14	1	U1	STUSB4500	Standalone USB PD controller with SINK auto-run mode in QFN24 4x4mm	ST	STUSB4500QTR

5 Board layout

Figure 4. STREF-SCS001V1: Dimensions

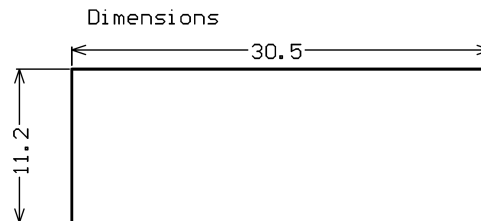

Figure 5. STREF-SCS001V1: Drill guide

Drill Guide

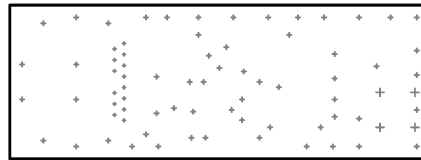

Figure 6. STREF-SCS001V1: Top layer

Top Layer

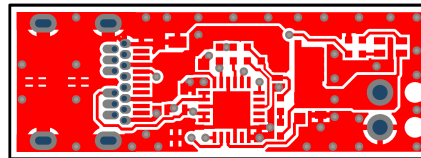

Figure 7. STREF-SCS001V1: Bottom layer

Bottom Layer

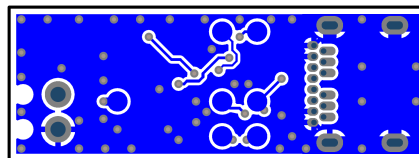

Figure 8. STREF-SCS001V1: Top silkscreen

Top Overlay

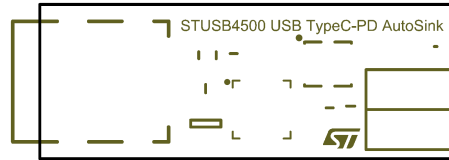

Figure 9. STREF-SCS001V1: Bottom silkscreen

Bottom Overlay



Figure 10. STREF-SCS001V1: Top solder resist

Top Solder

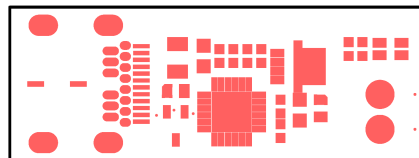

Figure 11. STREF-SCS001V1: Bottom solder resist

Bottom Solder

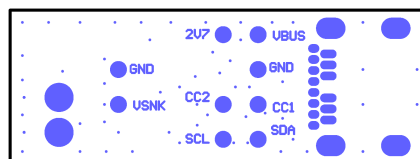

Figure 12. STREF-SCS001V1: Top solder paste

Top Paste

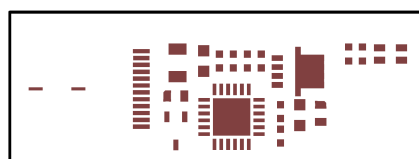

Figure 13. STREF-SCS001V1: Bottom solder paste

Bottom Paste



Figure 14. STREF-SCS001V1: Top assembly

Top Assembly

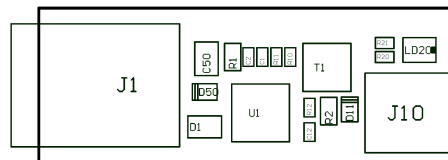

Figure 15. STREF-SCS001V1: Bottom assembly

Bottom Assembly

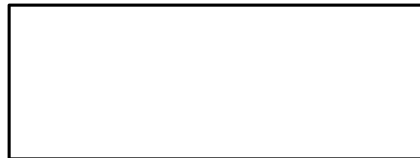

Figure 16. STREF-SCS001V1: Top assembly (composite)

Top Assembly

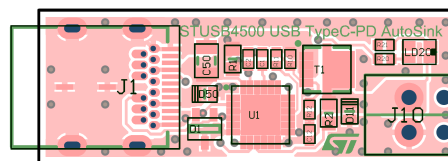
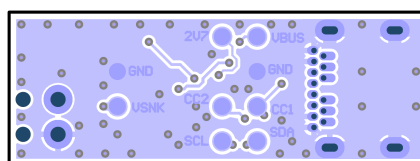

Figure 17. STREF-SCS001V1: Bottom assembly (composite)

Bottom Assembly



5.1 Layout constraints

The VBUS connection to the PMOS Source must be as direct as possible. Use a wide track or routing plane and place the clamping diode (TVS) and input capacitor on this track (no stub or distant connection).

Similarly, the VSNK connection from the PMOS Drain must be as direct as possible. Use a wide track or routing plane and place the clamping diode (TVS) and output capacitor on this track (no stub or distant connection).

The ground path must have the lowest possible resistance.

The STSUB4500 decoupling capacitors must be placed close to the 1V2 and 2V7 pads. You should not use these voltages sources for other purposes.

Protection diodes (such as the ESDA25W) should be placed on the CC1 and CC2 lines. You should have a direct connection from the Type-C connector pin to the diode pad, and a direct connection from diode pad to the STUSB4500 pad.

6 Board customization

The STUSB4500 has embedded Non-Volatile Memory (NVM) for off-line parameter storage (such as PDO values). This memory can be set via the I2C interface using STSW-STUSB002 software and an NUCLEO-F072RB board. The PADS for I2C connection are available on the bottom of the board. Solder wires between these pads and the Nucleo board:

- GND to Nucleo CN10 pin 9
- SCL to Nucleo CN10 pin 3
- SDA to Nucleo CN10 pin 5

Please refer to STSW-STUSB002 documentation for further details.

Revision history

Table 1. Document revision history

Date	Version	Changes
08-Jan-2019	1	Initial release.

Contents

1	Functional diagram	2
2	Getting started	3
3	Schematic diagram	4
4	Bill of material	5
5	Board layout	6
5.1	Layout constraints	8
6	Board customization	10
	Revision history	11
	Contents	12
	List of tables	13
	List of figures	14

List of tables

Table 1. Document revision history 11

List of figures

Figure 1.	STREF-SCS001V1 board photo	1
Figure 2.	STREF-SCS001V1 functional diagram.	2
Figure 3.	STREF-SCS001V1 schematic	4
Figure 4.	STREF-SCS001V1: Dimensions	6
Figure 5.	STREF-SCS001V1: Drill guide	6
Figure 6.	STREF-SCS001V1: Top layer.	6
Figure 7.	STREF-SCS001V1: Bottom layer	6
Figure 8.	STREF-SCS001V1: Top silkscreen	7
Figure 9.	STREF-SCS001V1: Bottom silkscreen.	7
Figure 10.	STREF-SCS001V1: Top solder resist	7
Figure 11.	STREF-SCS001V1: Bottom solder resist	7
Figure 12.	STREF-SCS001V1: Top solder paste	7
Figure 13.	STREF-SCS001V1: Bottom solder paste	8
Figure 14.	STREF-SCS001V1: Top assembly	8
Figure 15.	STREF-SCS001V1: Bottom assembly	8
Figure 16.	STREF-SCS001V1: Top assembly (composite).	8
Figure 17.	STREF-SCS001V1: Bottom assembly (composite)	8

IMPORTANT NOTICE – PLEASE READ CAREFULLY

STMicroelectronics NV and its subsidiaries (“ST”) reserve the right to make changes, corrections, enhancements, modifications, and improvements to ST products and/or to this document at any time without notice. Purchasers should obtain the latest relevant information on ST products before placing orders. ST products are sold pursuant to ST’s terms and conditions of sale in place at the time of order acknowledgement.

Purchasers are solely responsible for the choice, selection, and use of ST products and ST assumes no liability for application assistance or the design of Purchasers’ products.

No license, express or implied, to any intellectual property right is granted by ST herein.

Resale of ST products with provisions different from the information set forth herein shall void any warranty granted by ST for such product.

ST and the ST logo are trademarks of ST. All other product or service names are the property of their respective owners.

Information in this document supersedes and replaces information previously supplied in any prior versions of this document.

© 2019 STMicroelectronics – All rights reserved