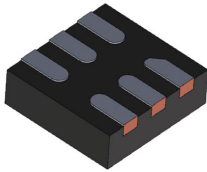
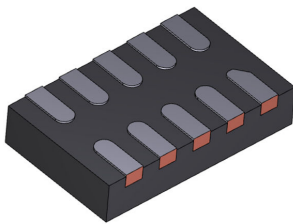


Common mode filter with ESD protection for high speed serial interface



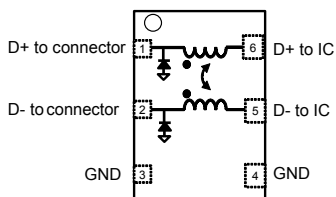
μQFN-6L (Bottom view)
1.35 mm x 1.4 mm x 0.5mm



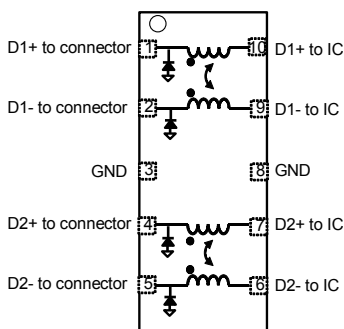
μQFN-10L (Bottom view)
1.35 mm x 2.2 mm x 0.5mm

Functional schematic

ECMF2-40A100N6



ECMF4-40A100N10



Features

- 10.7 GHz differential bandwidth to comply with HDMI 2.1, HDMI 2.0, HDMI 1.4, USB4, USB 3.2 Gen2, USB 2.0, MIPI, Display port 2.0, etc.
- High common mode attenuation on WLAN frequencies:
 - -15 dB at 2.4 GHz
 - -21 dB at 5.0 GHz
 - -17 dB at 6.0 GHz
- Low serial resistance: 3.0 Ω
- Very low PCB space consumption
- Thin package: 0.5 mm max.
- High reduction of parasitic elements through integration
- Lead free and RoHS package
- Exceeds IEC 61000-4-2 level 4 standard:
 - Contact discharge:
 - ±9 kV (contact discharge, ECMF2-40A100N6)
 - ±10 kV (contact discharge, ECMF4-40A100N10)
 - Air discharge:
 - ±20 kV (air discharge, ECMF2-40A100N6)
 - ±25 kV (air discharge, ECMF4-40A100N10)

Applications

- Notebook, laptop
- Streaming box, HDMI stick
- Game console, Set top box
- Tablet
- Portable devices

Description

The ECMF2-40A100N6 and ECMF4-40A100N10 are highly integrated common mode filters designed to suppress EMI/RFI common mode noise on high speed differential serial buses like HDMI 2.1, HDMI 2.0, HDMI1.4, USB4, USB 3.2 Gen 2, USB 2.0, ethernet, MIPI, Display Port and other high speed serial interfaces.

They have a very large differential bandwidth to comply with these standards and can also protect and filter one or two differential lanes.

Product status	
Part number	Package
ECMF2-40A100N6	μQFN-6L
ECMF4-40A100N10	μQFN-10L

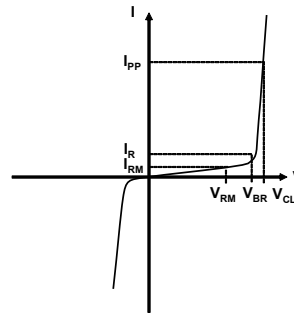
1 Characteristics

Table 1. Absolute maximum ratings ($T_{amb} = 25\text{ °C}$)

Symbol	Parameter	Value	Unit	
V_{PP}	Peak pulse voltage	IEC 61000-4-2 contact discharge:		
		ECMF2-40A100N6	± 9	kV
		ECMF4-40A100N10	± 10	
		IEC 61000-4-2 air discharge:		
	ECMF2-40A100N6	± 20	kV	
	ECMF4-40A100N10	± 25		
I_{RMS}	Maximum RMS current	100	mA	
T_{op}	Maximum operating temperature range	-55 to +125	°C	
T_{stg}	Storage temperature range	-55 to +150		
T_L	Maximum temperature for soldering during 10 s	260		

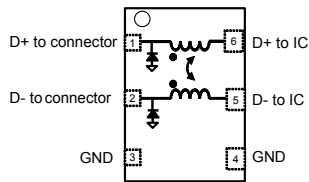
Figure 1. Electrical characteristics (definitions)

- V_{RM} Maximum stand-off voltage
- V_{CL} Clamping voltage at peak pulse current I_{PP}
- I_{RM} Leakage current at V_{RM}
- I_{PP} Peak pulse current
- V_{BR} Breakdown voltage
- C_{DIODE} ESD diode capacitance
- R_{DC} DC serial resistance
- f_c Differential cut off frequency

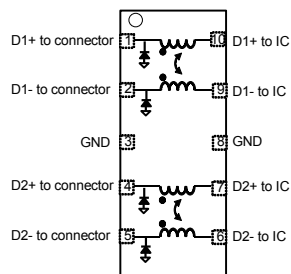

Table 2. Electrical characteristics ($T_{amb} = 25\text{ °C}$)

Symbol	Parameter	Test conditions	Min.	Typ.	Max.	Unit
V_{BR}	Breakdown voltage	$I_R = 1\text{ mA}$	5.3	5.8		V
I_{RM}	Leakage current	$V_{RM} = 3.6\text{ V per line}$		< 1	50	nA
		$V_{RM} = 5\text{ V per line}$		3	70	
V_{RM}	Reverse working voltage				5	V
R_{DC}	DC serial resistance, $I_{DC} = 20\text{ mA}$			3.0		Ω
f_c	Differential mode cut-off frequency ⁽¹⁾			10.7		GHz
V_{CL}	Reverse clamping voltage	TLP measurement (pulse duration 100 ns), 16 A I_{PP}		20.5		V
		8 kV contact discharge after 30 ns, IEC 61000-4-2		18		
C_{DIODE}	Capacitance	$V_{BIAS} = 0\text{ V}$, $F = 2.5\text{ GHz to }9\text{ GHz}$, $V_{OSC} = 30\text{ mV}$		0.25	0.40	pF
R_D	Dynamic resistance, TLP measurement (pulse duration 100 ns)			0.8		Ω

1. Attenuation at 10 MHz as reference.

Figure 2. Functional schematic (ECMF2-40A100N6)

Table 3. ECMF2-40A100N6 pin discription

Pin number	Description	Pin number	Description
1	D+ to connector	6	D+ to IC
2	D- to connector	5	D- to IC
3	GND	4	GND

Figure 3. Functional schematic (ECMF4-40A100N10)

Table 4. ECMF4-40A100N10 pin description

Pin number	Description	Pin number	Description
1	D1+ to connector	10	D1+ to IC
2	D1- to connector	9	D1- to IC
3	GND	8	GND
4	D2+ to connector	7	D2+ to IC
5	D2- to connector	6	D2- to IC

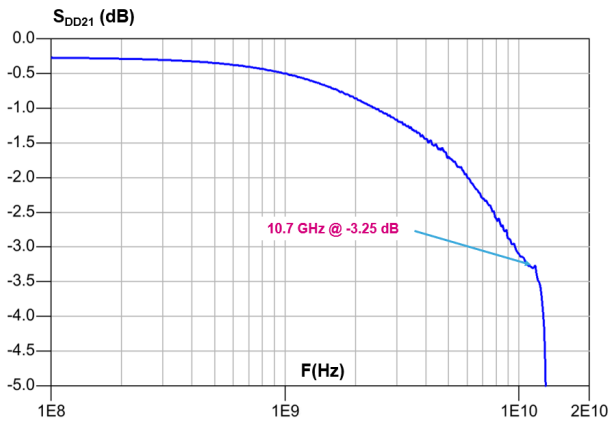
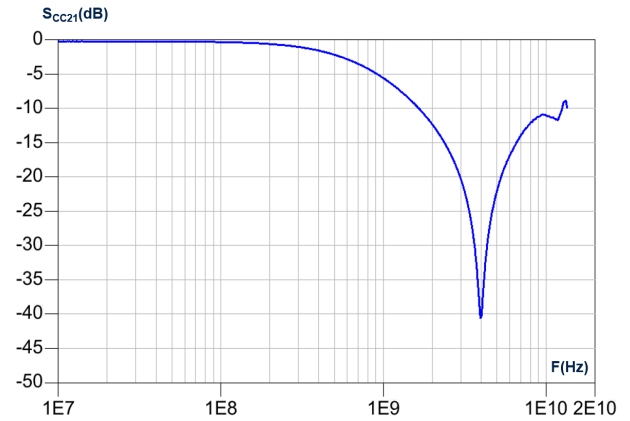
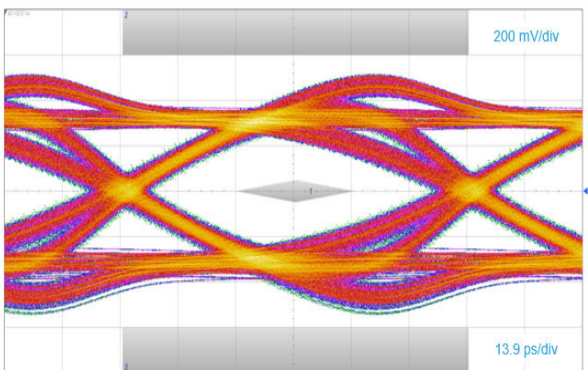
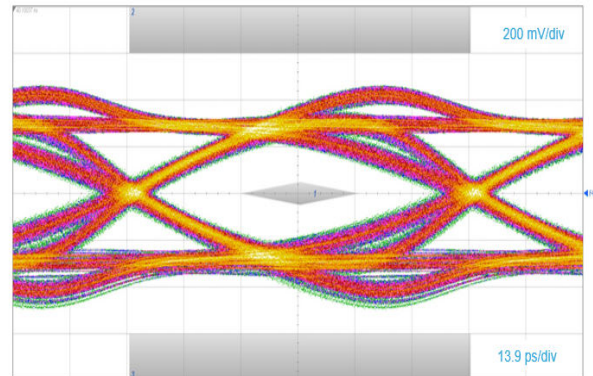
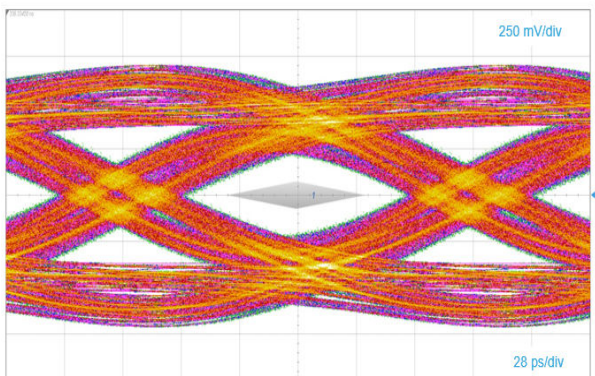
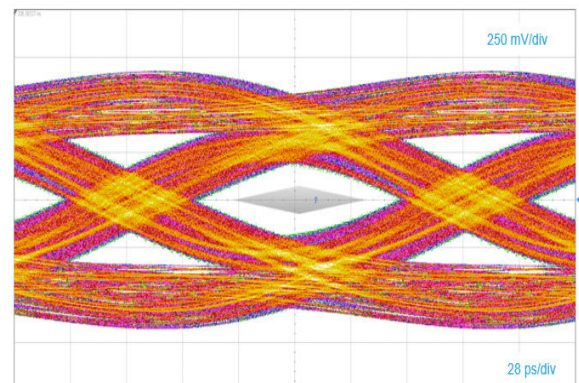
1.1 Characteristics (curves)
Figure 4. Differential attenuation versus frequency
 ($Z_{0\text{ DIFF}} = 100\ \Omega$)

Figure 5. Common mode attenuation versus frequency
 ($Z_{0\text{ COM}} = 50\ \Omega$)

Figure 6. HDMI2.1 12 Gbps eye diagram without
 ECMFx-40A100Nx (with worst cable model (WCM3),
 EQ with 8 dB CTLE and One-tap DFE)

Figure 7. HDMI2.1 12 Gbps eye diagram with
 ECMFx-40A100Nx (with worst cable model (WCM3),
 EQ with 8 dB CTLE and One-tap DFE)

Figure 8. HDMI2.0 5.94 Gbps eye diagram without
 ECMFx-40A100Nx (with worst cable model and equalizer)

Figure 9. HDMI2.0 5.94 Gbps eye diagram with
 ECMFx-40A100Nx (with worst cable model and equalizer)


Figure 10. USB4 20.0 Gbps eye diagram without ECMFx-40A100Nx (with Preset 0, reference cable 0.8m, equalizer with ADC = 0dB and DFE)

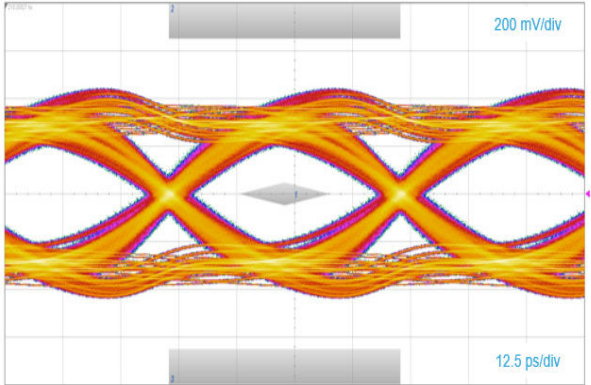


Figure 11. USB4 20.0 Gbps eye diagram with ECMFx-40A100Nx (with Preset 0, reference cable 0.8m, equalizer with ADC = 0dB and DFE)

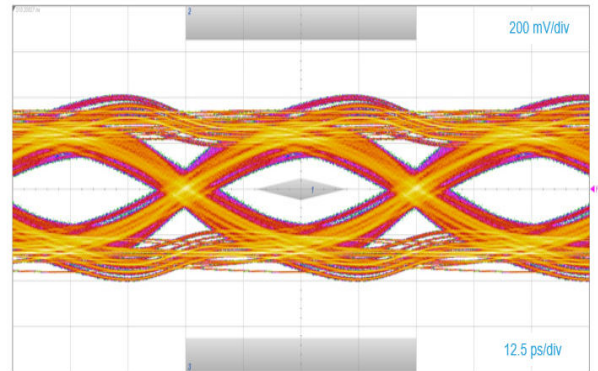


Figure 12. USB3.2 Gen 2 10.0 Gbps eye diagram without ECMFx-40A100Nx (with type C connector, reference cable, equalizer with ADC = 5 dB and DFE)

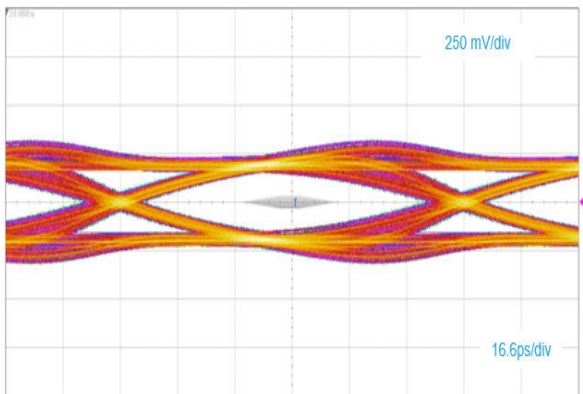


Figure 13. USB3.2 Gen 2 10.0 Gbps eye diagram with ECMFx-40A100Nx (with type C connector, reference cable, equalizer with ADC = 5 dB and DFE)

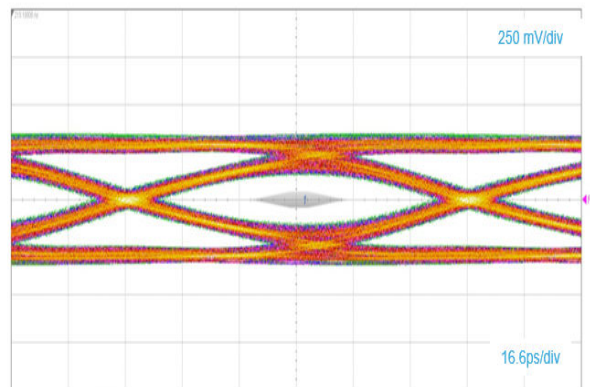


Figure 14. USB3.2 Gen 1 5.0 Gbps eye diagram without ECMFx-40A100Nx (with type C connector, reference cable and equalizer)

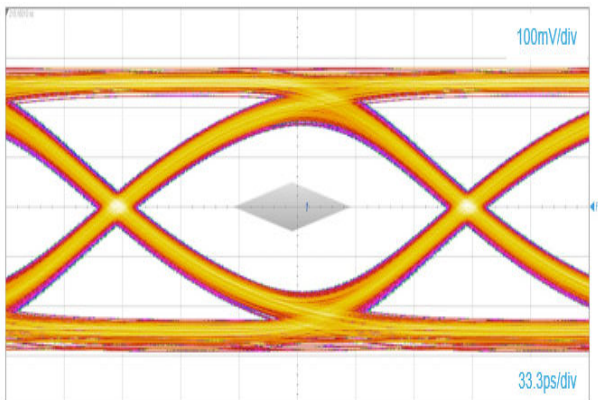


Figure 15. USB3.2 Gen 1 5.0 Gbps eye diagram with ECMFx-40A100Nx (with type C connector, reference cable and equalizer)

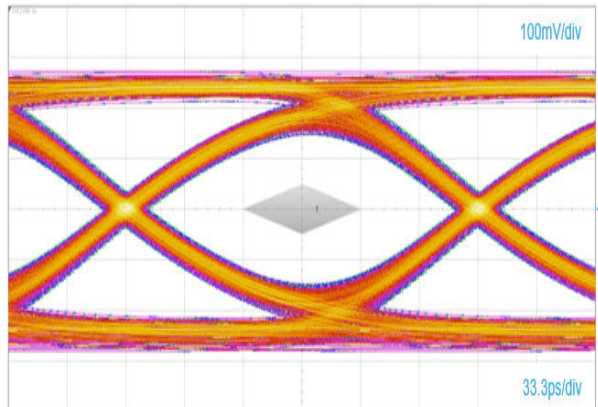


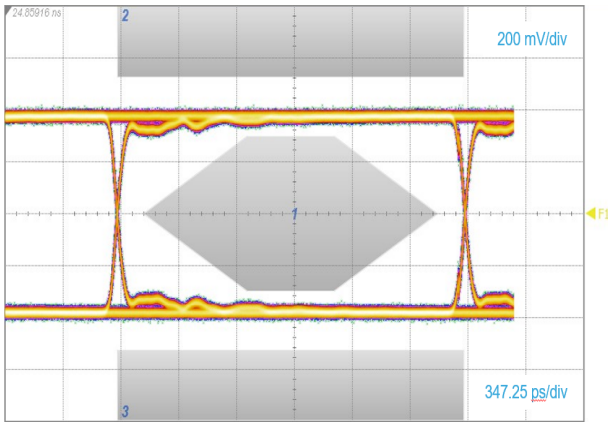
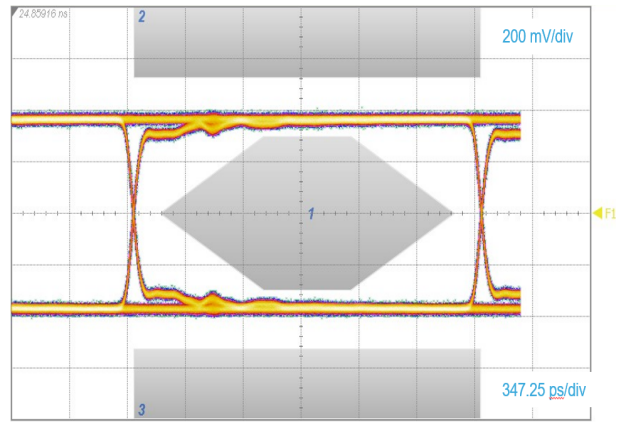
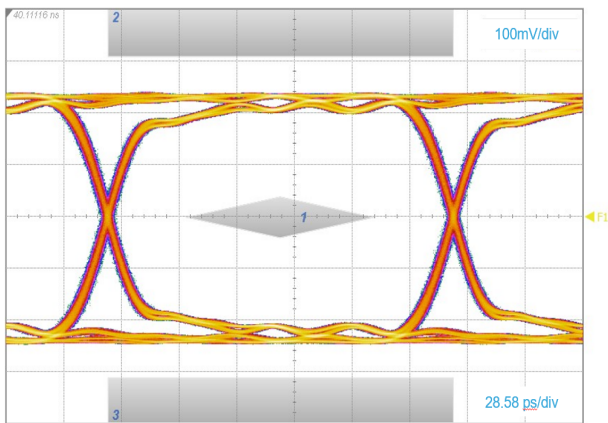
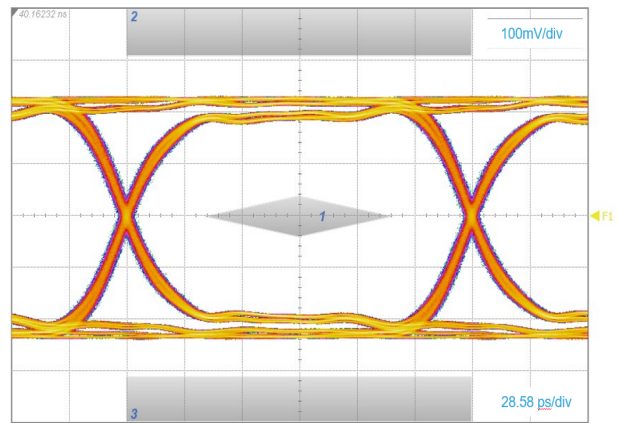
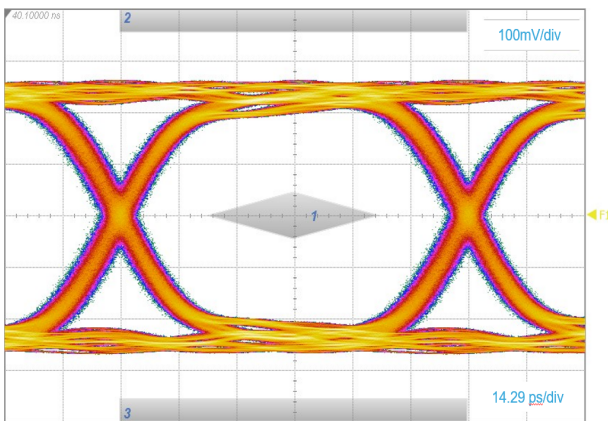
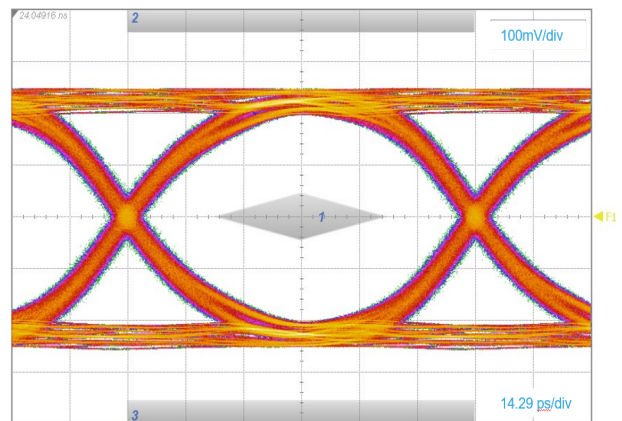
Figure 16. USB 2.0 High Speed 480 Mbps eye diagram, Template 1, without ECMFx-40A100Nx

Figure 17. USB 2.0 High Speed 480 Mbps eye diagram, Template 1, with ECMFx-40A100Nx

Figure 18. MIPI M-PHY – Gear 3 at 5.83 Gbps eye diagram without ECMFx-40A100Nx

Figure 19. MIPI M-PHY – Gear 3 at 5.83 Gbps eye diagram with ECMFx-40A100Nx

Figure 20. MIPI M-PHY – Gear 4 at 11.66 Gbps eye diagram without ECMFx-40A100Nx

Figure 21. MIPI M-PHY – Gear 4 at 11.66 Gbps eye diagram with ECMFx-40A100Nx


Figure 22. ESD response to IEC61000-4-2 (+8 kV contact discharge)

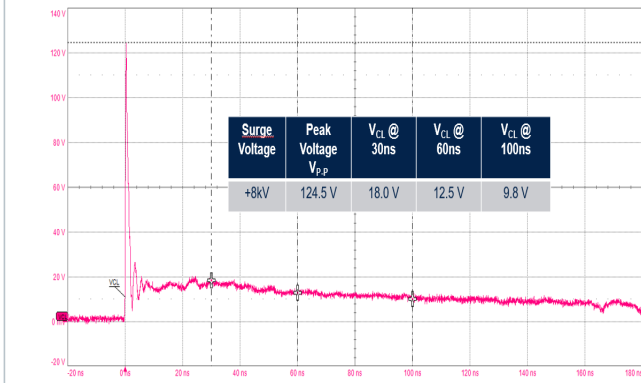


Figure 23. ESD response to IEC61000-4-2 (-8 kV contact discharge)

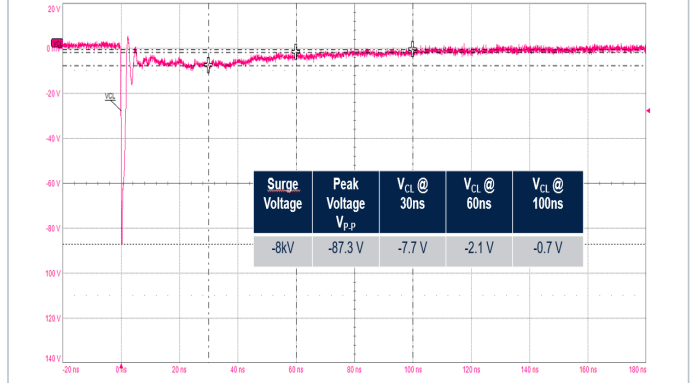
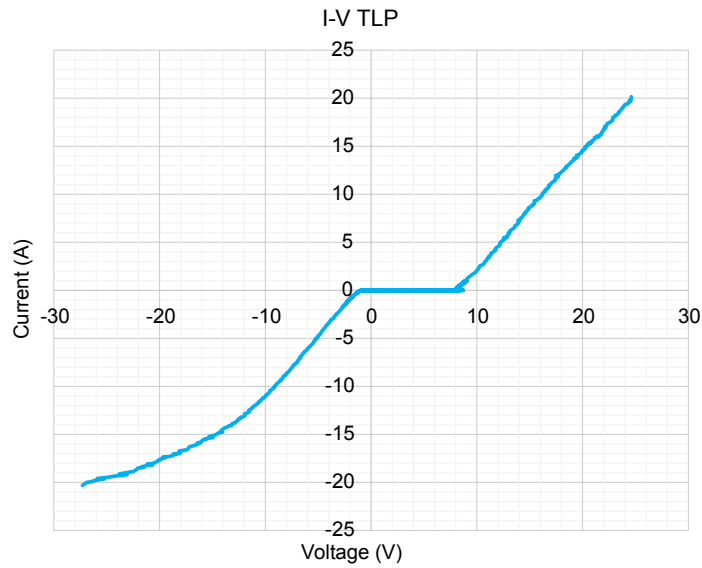


Figure 24. TLP characteristic



2 Package information

To meet environmental requirements, ST offers these devices in different grades of **ECOPACK** packages, depending on their level of environmental compliance. ECOPACK specifications, grade definitions, and product status are available at: www.st.com. ECOPACK is an ST trademark.

2.1 μ QFN6L package information

Figure 25. μ QFN6L package outline

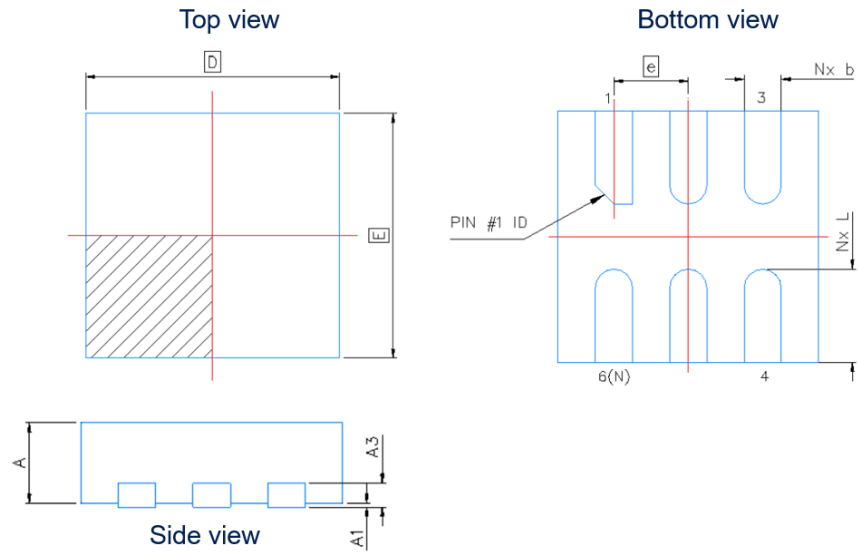
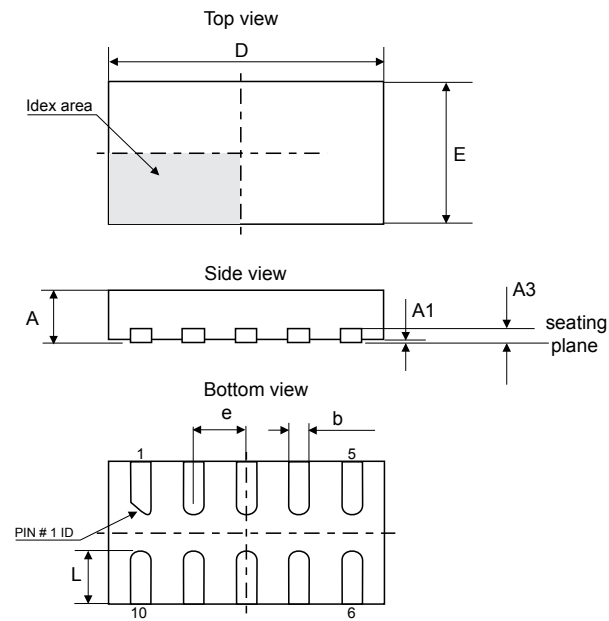


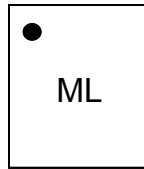
Table 5. μ QFN6L package mechanical data

Ref.	Dimensions		
	Millimeters		
	Min.	Typ.	Max.
A	0.41	0.45	0.50
A1	0.00	0.02	0.05
A3		0.127	
b	0.15	0.20	0.25
D	1.35	1.40	1.45
E	1.30	1.35	1.40
e		0.40	
L	0.40	0.50	0.60
N		6	

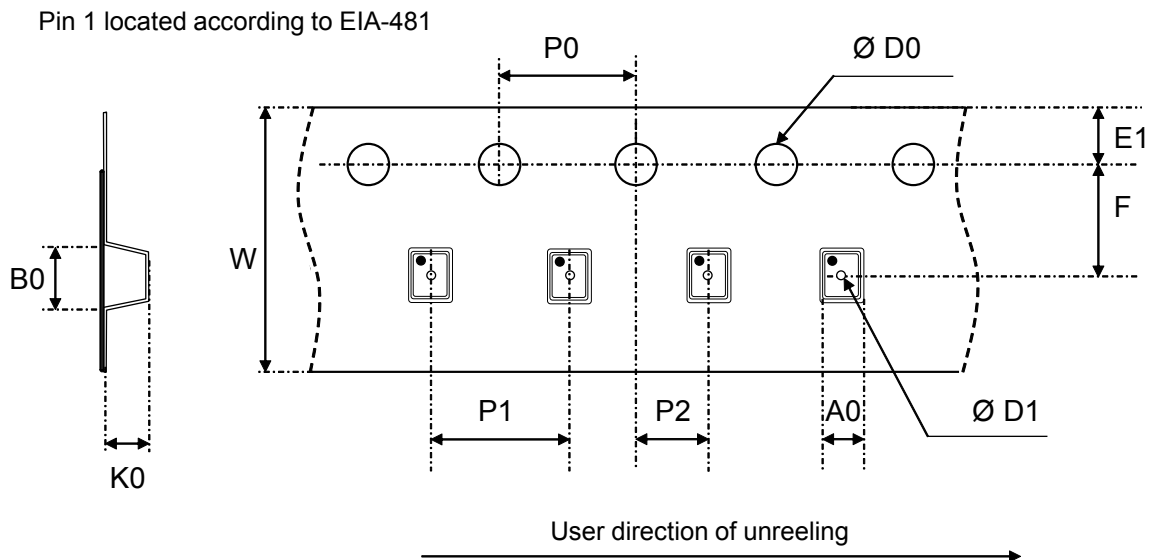
2.2 μ QFN10L package information

Figure 26. μ QFN10L package outline

Table 6. μ QFN10L package mechanical data

Ref.	Dimensions		
	Millimeters		
	Min.	Typ.	Max.
A	0.41	0.45	0.50
A1	0.00	0.02	0.05
A3		0.127	
b	0.15	0.20	0.25
D	2.15	2.20	2.25
E	1.30	1.35	1.40
e		0.40	
L	0.40	0.50	0.60

2.3 Packing information
Figure 27. ECMF2-40A100N6 marking

Figure 28. ECMF4-40A100N10 marking


Note: The marking codes can be rotated by 90 ° or 180° to differentiate assembly location. In no case should this product marking be used to orient the component for its placement on a PCB. Only pin 1 mark is to be used for this purpose.

Figure 29. Tape and reel outline


Note: Pocket dimensions are not on scale
 Pocket shape may vary depending on package

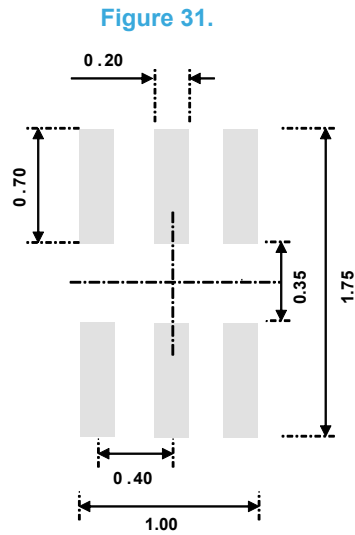
Table 7. Tape and reel mechanical data

Ref.	Dimensions (millimeters)		
	Min.	Typ.	Max.
P1	3.90	4.00	4.10
P0	3.90	4.00	4.10
Ø D0	1.40	1.50	1.60
Ø D1 (ECMF2-40A100N6)	0.45	0.50	0.55
Ø D1 (ECMF4-40A100N10)	0.8		
F	3.45	3.50	3.55
E1	1.65	1.75	1.85
K0 (ECMF2-40A100N6)	0.70	0.75	0.80
K0 (ECMF4-40A100N10)	0.60	0.65	0.70
P2	1.95	2.00	2.05
W	7.90	8.00	8.10
A0 (ECMF2-40A100N6)	1.43	1.48	1.53
A0 (ECMF4-40A100N10)	1.50	1.55	1.60
B0 (ECMF2-40A100N6)	1.75	1.80	1.85
B0 (ECMF4-40A100N10)	2.35	2.40	2.45

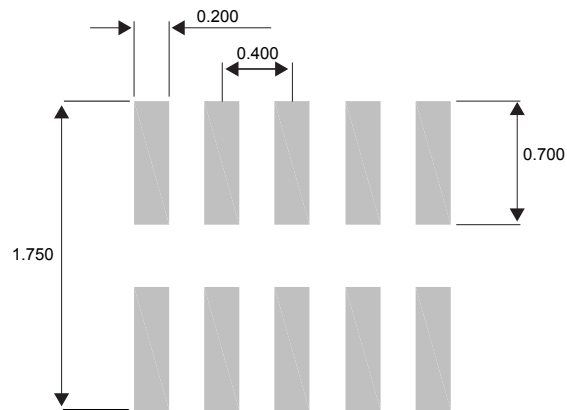
3 Recommendation on PCB assembly

3.1 Footprint

Figure 30. ECMF2-40A100N6 footprint in mm



ECMF4-40A100N10 footprint in mm



SMD footprint design is recommended.

3.2 Stencil opening design

Recommended design reference: stencil opening thickness: 100 μm

Figure 32. ECMF2-40A100N6 stencil opening recommendations

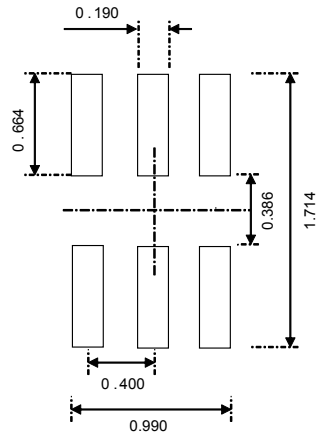
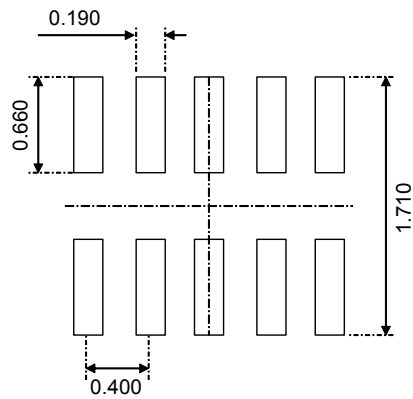


Figure 33. ECMF4-40A100N10 stencil opening recommendations



3.3 Solder paste

1. Halide-free flux qualification ROL0 according to ANSI/J-STD-004.
2. "No clean" solder paste is recommended.
3. Offers a high tack force to resist component movement during PCB movement.
4. Solder paste with fine particles: powder particle size is 20-38 μm .

3.4 Placement

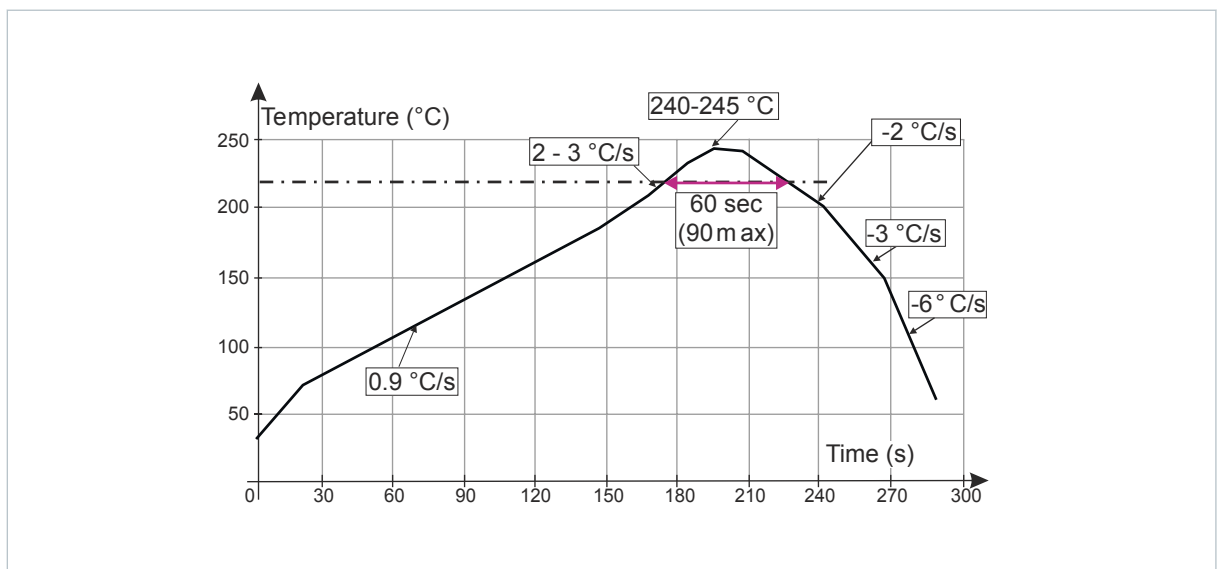
1. Manual positioning is not recommended.
2. It is recommended to use the lead recognition capabilities of the placement system, not the outline centering
3. Standard tolerance of ± 0.05 mm is recommended.
4. 3.5 N placement force is recommended. Too much placement force can lead to squeezed out solder paste and cause solder joints to short. Too low placement force can lead to insufficient contact between package and solder paste that could cause open solder joints or badly centered packages.
5. To improve the package placement accuracy, a bottom side optical control should be performed with a high resolution tool.
6. For assembly, a perfect supporting of the PCB (all the more on flexible PCB) is recommended during solder paste printing, pick and place and reflow soldering by using optimized tools.

3.5 PCB design preference

1. To control the solder paste amount, the closed via is recommended instead of open vias.
2. The position of tracks and open vias in the solder area should be well balanced. A symmetrical layout is recommended, to avoid any tilt phenomena caused by asymmetrical solder paste due to solder flow away.

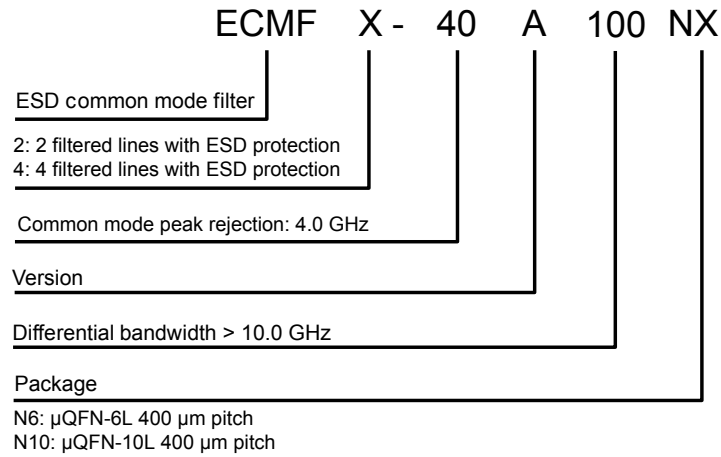
3.6 Reflow profile

Figure 34. ST ECOPACK[®] recommended soldering reflow profile for PCB mounting



Note: Minimize air convection currents in the reflow oven to avoid component movement. Maximum soldering profile corresponds to the latest IPC/JEDEC J-STD-020.

4 Ordering information

Figure 35. Ordering information scheme

Table 8. Ordering information

Order code	Marking ⁽¹⁾	Package	Weight	Base qty.	Delivery mode
ECMF2-40A100N6	ML	μ QFN-6L	2.4 mg	3000	Tape and reel
ECMF4-40A100N10	MK	μ QFN-10L	3.9 mg	3000	Tape and reel

1. The marking can be rotated by 90° to differentiate assembly location

Revision history

Table 9. Document revision history

Date	Revision	Changes
14-Feb-2022	1	Initial release.
19-May-2022	2	Added from <i>Figure 15</i> to <i>Figure 20</i> .
27-Sep-2022	3	Updated <i>Figure 3</i> .
30-Jan-2025	4	Updated Section Cover image , Section Pin configuration , Figure 2 , Table 3 , Figure 3 , and Table 4 .



IMPORTANT NOTICE – READ CAREFULLY

STMicroelectronics NV and its subsidiaries (“ST”) reserve the right to make changes, corrections, enhancements, modifications, and improvements to ST products and/or to this document at any time without notice. Purchasers should obtain the latest relevant information on ST products before placing orders. ST products are sold pursuant to ST’s terms and conditions of sale in place at the time of order acknowledgment.

Purchasers are solely responsible for the choice, selection, and use of ST products and ST assumes no liability for application assistance or the design of purchasers’ products.

No license, express or implied, to any intellectual property right is granted by ST herein.

Resale of ST products with provisions different from the information set forth herein shall void any warranty granted by ST for such product.

ST and the ST logo are trademarks of ST. For additional information about ST trademarks, refer to www.st.com/trademarks. All other product or service names are the property of their respective owners.

Information in this document supersedes and replaces information previously supplied in any prior versions of this document.

© 2025 STMicroelectronics – All rights reserved